



University of Kentucky  
UKnowledge

---

Theses and Dissertations--Computer Science

Computer Science

---

2018

## SDN-BASED MECHANISMS FOR PROVISIONING QUALITY OF SERVICE TO SELECTED NETWORK FLOWS

Faisal Alharbi

University of Kentucky, fbadrany@gmail.com

Digital Object Identifier: <https://doi.org/10.13023/etd.2018.317>

[Right click to open a feedback form in a new tab to let us know how this document benefits you.](#)

---

### Recommended Citation

Alharbi, Faisal, "SDN-BASED MECHANISMS FOR PROVISIONING QUALITY OF SERVICE TO SELECTED NETWORK FLOWS" (2018). *Theses and Dissertations--Computer Science*. 72.  
[https://uknowledge.uky.edu/cs\\_etds/72](https://uknowledge.uky.edu/cs_etds/72)

This Doctoral Dissertation is brought to you for free and open access by the Computer Science at UKnowledge. It has been accepted for inclusion in Theses and Dissertations--Computer Science by an authorized administrator of UKnowledge. For more information, please contact [UKnowledge@lsv.uky.edu](mailto:UKnowledge@lsv.uky.edu).

## STUDENT AGREEMENT:

I represent that my thesis or dissertation and abstract are my original work. Proper attribution has been given to all outside sources. I understand that I am solely responsible for obtaining any needed copyright permissions. I have obtained needed written permission statement(s) from the owner(s) of each third-party copyrighted matter to be included in my work, allowing electronic distribution (if such use is not permitted by the fair use doctrine) which will be submitted to UKnowledge as Additional File.

I hereby grant to The University of Kentucky and its agents the irrevocable, non-exclusive, and royalty-free license to archive and make accessible my work in whole or in part in all forms of media, now or hereafter known. I agree that the document mentioned above may be made available immediately for worldwide access unless an embargo applies.

I retain all other ownership rights to the copyright of my work. I also retain the right to use in future works (such as articles or books) all or part of my work. I understand that I am free to register the copyright to my work.

## REVIEW, APPROVAL AND ACCEPTANCE

The document mentioned above has been reviewed and accepted by the student's advisor, on behalf of the advisory committee, and by the Director of Graduate Studies (DGS), on behalf of the program; we verify that this is the final, approved version of the student's thesis including all changes required by the advisory committee. The undersigned agree to abide by the statements above.

Faisal Alharbi, Student

Dr. Zongming Fei, Major Professor

Dr. Miroslaw Truszczynski, Director of Graduate Studies

SDN-BASED MECHANISMS FOR PROVISIONING QUALITY OF SERVICE TO  
SELECTED NETWORK FLOWS

---

DISSERTATION

---

A dissertation submitted in partial  
fulfillment of the requirements for  
the degree of Doctor of Philosophy  
in the College of Engineering at the  
University of Kentucky

By  
Faisal Alharbi  
Lexington, Kentucky

Director: Dr. Zongming Fei, Professor of Computer Science  
Lexington, Kentucky 2018

Copyright© Faisal Alharbi 2018

## ABSTRACT OF DISSERTATION

### SDN-BASED MECHANISMS FOR PROVISIONING QUALITY OF SERVICE TO SELECTED NETWORK FLOWS

Despite the huge success and adoption of computer networks in the recent decades, traditional network architecture falls short of some requirements by many applications. One particular shortcoming is the lack of convenient methods for providing quality of service (QoS) guarantee to various network applications. In this dissertation, we explore new Software-Defined Networking (SDN) mechanisms to provision QoS to targeted network flows. Our study contributes to providing QoS support to applications in three aspects. First, we explore using alternative routing paths for selected flows that have QoS requirements. Instead of using the default shortest path used by the current network routing protocols, we investigate using the SDN controller to install forwarding rules in switches that can achieve higher bandwidth. Second, we develop new mechanisms for guaranteeing the latency requirement by those applications depending on timely delivery of sensor data and control signals. The new mechanism pre-allocates higher priority queues in routers/switches and reserves these queues for control/sensor traffic. Third, we explore how to make the applications take advantage of the opportunity provided by SDN. In particular, we study new transmission mechanisms for big data transfer in the cloud computing environment. Instead of using a single TCP path to transfer data, we investigate how to let the application set up multiple TCP paths for the same application to achieve higher throughput. We evaluate these new mechanisms with experiments and compare them with existing approaches.

**KEYWORDS:** Software Defined Networking, Quality of Service, Network Architecture, Multipath TCP

Author's signature: Faisal Alharbi

Date: July 31, 2018

SDN-BASED MECHANISMS FOR PROVISIONING QUALITY OF SERVICE TO  
SELECTED NETWORK FLOWS

By  
Faisal Alharbi

Director of Dissertation: Dr. Zongming Fei

Director of Graduate Studies: Dr. Miroslaw Truszczynski

Date: July 31, 2018

## ACKNOWLEDGMENTS

I would like to express my sincere appreciation to my advisor, Dr. Zongming Fei, for all the guidance and support I received from him. I am grateful to Dr. Fei for giving me the opportunity to work with him and for providing endless support and encouragement throughout the entire PhD journey.

I also want to thank the members of my Doctoral Advisory Committee: Dr. Dakshnamoorthy Manivannan, Dr. Jinze Liu, and Dr. Yuan Liao for their guidance and feedback.

Finally, I would like to thank my employer, King Abdulaziz City for Science and Technology, for granting me the scholarship.

## TABLE OF CONTENTS

Acknowledgments . . . . .	iii
Table of Contents . . . . .	iv
List of Figures . . . . .	vi
List of Tables . . . . .	vii
Chapter 1 Introduction . . . . .	1
1.1 Overview . . . . .	1
1.2 Contributions . . . . .	4
1.3 Organization . . . . .	5
Chapter 2 Background . . . . .	6
2.1 Quality of Service . . . . .	6
2.1.1 IntServ . . . . .	6
2.1.2 DiffServ . . . . .	7
2.1.3 QoS Metrics . . . . .	8
2.1.4 QoS Routing . . . . .	10
2.2 Software-Defined Networking (SDN) . . . . .	13
2.2.1 Early Efforts Prior to SDN . . . . .	13
Routing Control Platform . . . . .	13
The 4D project . . . . .	14
Ethane . . . . .	16
2.2.2 SDN Model . . . . .	17
2.2.3 SDN Characteristics . . . . .	18
2.2.4 SDN Benefits . . . . .	19
2.2.5 OpenFlow . . . . .	20
2.2.6 Open vSwitch . . . . .	22
Chapter 3 Improving the Quality of Service for Bandwidth-Demanding Traffic Flows . . . . .	24
3.1 Overview . . . . .	24
3.2 Related Work . . . . .	25
3.3 An SDN-Based Framework for Setting Up Paths for Bandwidth-Demanding Flows . . . . .	26
3.3.1 Status Monitoring . . . . .	27
3.3.2 QoS-based Path Setup . . . . .	29
3.4 Evaluation . . . . .	33
3.4.1 First Experiment . . . . .	33
Experiment Setup . . . . .	33

Results . . . . .	33
3.4.2 Second Experiment . . . . .	39
Experiment Setup . . . . .	39
Results . . . . .	39
3.5 Summary . . . . .	40
Chapter 4 Provisioning Quality of Service to Latency-Sensitive Traffic Flows	42
4.1 Overview . . . . .	42
4.1.1 Motivation . . . . .	42
4.1.2 Latency Measurements in SDN . . . . .	47
4.1.3 Queueing Disciplines . . . . .	48
4.2 Related Work . . . . .	49
4.3 An SDN-based Architecture for Supporting Latency-Sensitive Flows .	50
4.3.1 Admission Control . . . . .	50
4.3.2 Queues Setup . . . . .	52
4.3.3 Installing OpenFlow Rules . . . . .	53
4.3.4 Monitoring and Reporting . . . . .	53
4.4 Provisioning QoS to Latency-Sensitive Flows . . . . .	53
4.5 Performance Evaluation . . . . .	56
4.6 Summary . . . . .	58
Chapter 5 Improving Throughput of Large Flows Using Multipath TCP . . .	59
5.1 Overview . . . . .	59
5.1.1 Motivation . . . . .	60
5.1.2 Data Center Topologies . . . . .	62
5.2 Multipath TCP . . . . .	62
5.2.1 Congestion Control . . . . .	65
5.3 Related Work . . . . .	69
5.4 SDN Based Architecture for Improving Throughput of Large Flows .	71
5.4.1 Load Balancing with OpenFlow Group Tables . . . . .	73
5.4.2 Routing Auxiliary Subflows . . . . .	75
5.4.3 Socket API for Creating Auxiliary Subflows . . . . .	80
5.5 Evaluation . . . . .	85
5.5.1 Experiments Setup . . . . .	85
5.5.2 Evaluation Results . . . . .	87
5.6 Summary . . . . .	90
Chapter 6 Conclusion . . . . .	92
6.1 Future Work . . . . .	93
Appendix . . . . .	95
Bibliography . . . . .	100
Vita . . . . .	105



## LIST OF FIGURES

2.1	Simplified SDN architecture . . . . .	18
3.1	The SDN architecture for providing QoS support . . . . .	28
3.2	Match fields in OpenFlow . . . . .	30
3.3	First experiment topology in Mininet . . . . .	34
3.4	Throughputs with five critical flows . . . . .	35
3.5	Throughputs for critical flows without QoS routing module . . . . .	36
3.6	Throughputs for critical flows with QoS routing module . . . . .	37
3.7	Throughputs with six critical flows . . . . .	38
3.8	Utilization of the whole network . . . . .	38
3.9	Second experiment topology in Mininet . . . . .	40
3.10	Average throughput to the number of accepted flows . . . . .	41
4.1	Effects of the total delay on user satisfaction (reprinted from [1]) . . . . .	44
4.2	Provisioning QoS architecture to latency-sensitive flows . . . . .	51
4.3	Example of different traffic classes . . . . .	55
4.4	Experiment topology . . . . .	57
4.5	Measured latency of control traffic messages . . . . .	57
5.1	Two examples of ECMP hash collision . . . . .	61
5.2	TCP and MPTCP protocol . . . . .	63
5.3	MPTCP subflows initiation . . . . .	65
5.4	Disjoint paths vs adaptive routing . . . . .	73
5.5	SDN-based architecture for improving throughput of large flows . . . . .	74
5.6	OpenFlow group table . . . . .	76
5.7	MPTCP option for MP_JOIN SYN packet . . . . .	77
5.8	Creating new subflow with with DSCP . . . . .	84
5.9	Network topology . . . . .	86
5.10	Average throughput of large flows . . . . .	88
5.11	Throughput of large flows (TM1) . . . . .	89
5.12	Throughput of large flows (TM2) . . . . .	89
5.13	Completion time of large flows (TM1) . . . . .	90
5.14	Completion time of large flows (TM2) . . . . .	90

## LIST OF TABLES

2.1	Sample of QoS routing problems solvable in polynomial time . . . . .	11
2.2	Sample of NP-Complete QoS routing problems . . . . .	13
3.1	Traffic flows . . . . .	34
5.1	Multipath TCP Option subtypes . . . . .	63

# Chapter 1

## Introduction

### 1.1 Overview

Data communication played a critical role in many computer applications and has become an essential part of our daily life, particularly due to the ubiquitous usage of mobile devices. These applications with a communication component have a wide range of requirements on the underlying computer networks. Traditional low data rate file transfer or interactive remote login to a shared machine has very limited requirements for the network, except reliability, which was handled by Transmission Control Protocol (TCP) through retransmission of lost packets. In contrast, more recently, applications such as video on demand, big data transfer, cyber physical systems, cloud computing, etc., present more stringent requirements from the time perspective, either measured as the latency or finishing time of data transfer, known as Quality of Service (QoS) requirements. For example, teleconferencing applications require audio/video data to be transferred with low packet delay to maintain the sense of real-time interaction. Video streaming requires sufficient bandwidth to play the video with little or no buffering. Otherwise it will cause interruption of playing the video at the receiving end. They may have other QoS requirements such as low jitter (variation in delay) and low packet loss ratio. For big data transfer applications, we

do not have strict deadline for packet delivery like in video streaming. However, we do rely on the networks to provide enough bandwidth so that the transfer can finish within a reasonable amount of time. In cyber physical systems such as smart grid and home networking systems, we may need to monitor the status of equipment and send control signals to initiate an operation. These sensor data and control signals need to reach their destinations in time to close the feedback loop, though the amount of data can be small. All these present challenges to the underlying networks.

Traditional network architecture does not provide QoS support for data communications. Even if the total network capacity can meet the requirements of network applications, the quality of service delivered for these applications can be unsatisfactory because of the best effort nature of the current network. There have been quite a lot of studies on the mechanisms for providing QoS in traditional networks. Most of them are theoretical studies and have not been deployed on the Internet at any significant scale.

One of the reasons is perhaps that the proprietary protocols deployed in network equipment by the vendors are mostly fixed and cannot be modified by end users. Vendors of networking devices usually do not want to expose their internal implementations to the public and tend to keep it closed, which make it difficult to program the network. This limits flexibility and makes network management more difficult. The network administrators cannot change their behaviors to meet the requirements of end applications. The network researchers cannot modify the software on network routers and switches to experiment, implement and deploy new protocols to provide QoS support required by the applications.

Software Defined Networking (SDN) is a recently proposed new paradigm for implementing network functions. It separates the control plane and data plane. Data plane is in charge of data forwarding functions while the control plane determines how the data are forwarded. The control plane function is centralized at the SDN

controller which installs forwarding rules that will be used by switches on the data plane. The open standard allows users to write controller modules to define the behavior of the data plane of the network. In addition, controllers provide northbound API interface for users to write external application programs that interact with the controller and have the capability to instruct what data forwarding switches should do with the data packets.

SDN provides a new opportunity for researchers to experiment new network mechanisms to provide the service required by applications. In this dissertation, we explore new SDN mechanisms to provision QoS to targeted network flows. From our analysis, we realized that there are two fundamental requirements for time-critical applications, i.e., bandwidth and latency. For bandwidth, instead of using the default destination-based routing algorithm, we explore alternative routing paths for selected flows. We take advantage of the flexibility provided SDN and install rules in the data forwarding switches, with the goal of using a forwarding path with higher available bandwidth, instead of using the default shortest path used by the current network routing protocols. To achieve the goal, we need to monitor the status of the network and develop a method to figure out the current available bandwidth on relevant links.

The other problem we want to address is latency. We are particularly interested in those applications that need the sensor data and control signals to be transmitted in a timely fashion so that the whole system can function properly. As a matter of fact, we cannot solve the problem caused by the limit of the speed of light. However, we do observe that one of the contributing factors is that these packets can wait in the queue when there is competing traffic that uses the same path. We develop a new mechanism that pre-allocates higher priority queues in routers/switches and reserves these queues for control/sensor traffic. It is an elastic reservation in the sense that if the bandwidth is not used by the reserved traffic, it can be used by others.

However, the reserved traffic has higher priorities. Therefore, it can guarantee that the control/sensor traffic is not delayed at congested routers to achieve the goal of keeping their end-to-end latency within the limit.

While the network can be equipped with mechanisms to install new routing paths, we also explore how to make the applications take advantage of the opportunity provided by SDN. From the application perspective, we study new transmission mechanisms for big data transfer in the cloud computing environment. Instead of using a single TCP path to transfer data, we investigate how to let the application set up multiple TCP paths for the same application. We differentiate short flows and long flows and adaptively determine whether to create subflows for a TCP connection and how many auxiliary subflows to create. With the knowledge about the network topology and available capacities provided by the SDN controller, we develop the algorithm that improves the overall throughput for long flows, without penalizing those short flows that do not need to use Multipath TCP (MPTCP).

## 1.2 Contributions

In this dissertation, we propose three mechanisms that aim to improve the provisioning of QoS to selected network flows. We identify the requirements of certain network traffic and present methods and systems to achieve their performance goals. These mechanisms are based on SDN. The proposed mechanisms have been developed and evaluated on testbed environments. The main contributions of this dissertation are:

- Improving the quality of service provided to traffic flows that have demands for bandwidth. We propose an SDN-based solution for continuous monitoring of network status and dynamically setting up forwarding paths for bandwidth-demanding traffic flows.

- Provisioning quality of service to latency-sensitive traffic. We propose a framework for managing and forwarding traffic flows that need to be transmitted with higher priority to meet deadlines. This framework accommodates different classes of traffic flows with different levels of requirements.
- Maximizing the throughput of large flows by using Multipath TCP and SDN. We propose a novel architecture that allows large traffic flows to achieve higher throughput by utilizing multiple paths. Our approach enables applications to dynamically create new subflows which are forwarded through least-congested paths by the SDN controller.

### 1.3 Organization

The rest of this dissertation is organized as follows. Chapter 2 provides background information related to QoS and SDN. Chapter 3 presents the SDN-based forwarding solution for improving QoS to bandwidth-demanding traffic flows. Chapter 4 describes provisioning QoS to latency-sensitive traffic. Chapter 5 presents our approach to improve the throughput of large flows by using Multipath TCP and SDN. Chapter 6 provides the conclusion and possible future research.

# Chapter 2

## Background

### 2.1 Quality of Service

Providing Quality of Service was not one of the goals in the initial design of the Internet. However, Internet applications (e.g., multimedia streaming, online-gaming, teleconferencing, etc.) evolved over time and their need for QoS guarantee became clear. Someone can argue that over-provisioning network resources to satisfy QoS requirements is economically more feasible than replacing existing network architecture. However, over the years there have been many efforts aimed at providing QoS. Integrated Services (IntServ) and Differentiated Services (DiffServ) were the two main proposals, although they were not successfully deployed on a large scale.

#### 2.1.1 IntServ

IntServ provides Quality of Service guarantee by reserving resources at each router along the path travelled by the packets of a flow. There are two parts of this architecture. First, the flow specification which describes the traffic flow and its requirements. The flow is defined as “distinguishable stream of related datagrams that results from a single user activity and requires the same QoS” [2]. Second, the



Resource Reservation Protocol (RSVP) [3] which is the signaling protocol used between hosts and routers to request reservation of resources (e.g., bandwidth). In order to provide the requested QoS, routers need to implement *traffic control*. The IntServ architecture defines three components of traffic control: packet scheduler, classifier, and admission control. Packet scheduler uses a set of queues to manage forwarding different packet streams. The classifier maps each incoming packet into some class. The admission control accepts or rejects a new QoS request for a traffic flow.

Although IntServ provides QoS guarantee, it has some drawbacks that prevented wide adoption of this architecture [4]. It requires maintaining flow state information which is proportional to the number of flows. This affects the scalability, especially in large networks like the Internet. It also requires all routers along the path to support the three components of traffic control and RSVP protocol. These limitations lead to the second proposal, DiffServ.

### 2.1.2 DiffServ

DiffServ was proposed to overcome the difficulties adopting IntServ. It provides mechanisms for aggregating traffic flows into classes. The coarse-grained traffic classes improve the scalability, in contrast with IntServs fine-grained traffic flows. The classification is done by utilizing Differentiated Services Code Point (DSCP) [5] field in the IPv4 and IPv6 headers. DSCP was introduced to replace ToS field in IPv4. The classified packets are marked so they can be identified by routers and forwarded accordingly. All packets that have the same DSCP value are grouped into one class called *Behavior Aggregate* and will be treated equally by all routers in the domain. The classifying and marking need to be performed only at the network edge. However, all routers need to implement *Per-Hop Behaviors (PHBs)* which describe properties for forwarding traffic classes (e.g., minimum bandwidth).

Per-Hop Behaviors ensure that high priority traffic will receive favorable treatment over other traffic classes. This is usually achieved by implementing different priority queues and traffic shaping (rate limiting). This architecture does not provide hard QoS guarantee like IntServ.

### 2.1.3 QoS Metrics

Quality of service requirements are typically stated in service level agreements (SLAs) that specify the guaranteed network performance to be provided for clients' applications by service providers. Network performance is measured against a set of attributes that include:

- Guaranteed minimum bandwidth. Throughput achieved by traffic streams is affected by several factors like link capacity and network congestion. Providing guaranteed minimum bandwidth to certain traffic flows (e.g., real-time video streaming) ensures that such flows will deliver data as required to the receiving end.
- Guaranteed maximum latency. End-to-end latency (delay) is the total time it takes for a single packet to be transmitted from the source host to the destination host. It involves transmission delay, propagation delay, queueing delay and processing delay. Voice over IP (VoIP), teleconferencing and online Internet gaming are examples of network applications that increased latency affects their performance.
- Guaranteed maximum packet loss ratio. Network congestion can lead to failure of delivering some packets. This can happen when buffers in network devices reach their maximum capacity. In this case, routers and switches will have to drop some packets. TCP, being a reliable transport protocol, ensures the integrity of transmitted data by employing receipt acknowledgements and

retransmitting lost packets. However, dropped packets affect the performance of TCP protocol as it is considered a congestion signal (identified by retransmission timeouts and duplicated acknowledgements). In response to congestion signal, the TCP congestion control algorithm will reduce the sending rate of the TCP stream to avoid congestion.

- Guaranteed maximum jitter (variation in latency). Network conditions change over time which can lead to different latency for packets belonging to the same traffic flow. This variation in latency is not desirable and can affect the quality of service for many applications like audio/video streaming and online Internet gaming.

Apart from over-provisioning network resources (which is not a cost-optimal solution), service providers can use mechanisms like resource reservation at each node along the path taken by data packets and QoS-aware routing. Resource reservation can involve giving higher priorities to certain traffic flows over other traffic. QoS-aware routing tries to route traffic flows through paths that satisfy QoS requirements.

Before going through the different types of QoS routing problems, we describe the representation of the network and its properties. The network is represented as a directed graph  $G(V, E)$ , where  $V$  is the set of all nodes in the network and  $E$  is the set of all links between nodes. Each link  $e \in E$  has associated properties:  $e_b$  is the available bandwidth capacity,  $e_d$  is the delay, and  $e_l$  is the ratio of packet loss (i.e., percentage of lost packets to the total number of packets; a ratio of 0 means no lost packets). The accuracy of these attributes is very crucial to the performance of QoS routing algorithms. The network state and measurements need to be updated in order for routing algorithms to find the most suitable paths with sufficient resources that meet required QoS parameters.

The path finding problem should return a path  $P$  from a source node  $s$  to a destination node  $d$  that satisfies the required QoS parameters. We define the following functions for a path  $P$  :

$$D(P) = \sum_{e \in P} e_d$$

$$B(P) = \min_{\forall e \in P} (e_b)$$

$$L(P) = 1 - \prod_{e \in P} (1 - e_l)$$

The delay function is additive while the bandwidth function is concave [6]. The packet loss ratio function is multiplicative but can be changed to additive by taking logarithm of the ratio .

#### 2.1.4 QoS Routing

The path finding problem in QoS routing can involve one or more QoS parameters. Algorithms for QoS routing have been studied extensively in the literature [7, 8]. Each required parameter can be either a constraint problem or an optimization problem. For example, a bandwidth constrained problem is defined as finding a path  $P$  such that each link in the path  $e \in P$  has available capacity larger than or equal to the required bandwidth parameter. The widest path problem, a bandwidth optimization problem, is defined as finding a path  $P$  that has the largest available capacity (i.e., maximizing the bottleneck of the suitable path). Table 2.1 shows a sample list of QoS routing problems that can be solved in polynomial time. For the simplest form, a single QoS parameter, variations of shortest path finding algorithms (e.g., Dijkstra algorithm or Bellman-Ford algorithm) can be used to solve the problem and find a suitable path. Some composite parameter problems (e.g., constrained-bandwidth

least-delay problem) can be solved in polynomial time by running the shortest path algorithm (weights of the graph edges are delay measurements) and removing the link that has available capacity less than the bandwidth constraint.

Table 2.1: Sample of QoS routing problems solvable in polynomial time

Attributes	Params	Constraint	Optimization	Notes
Bandwidth	$B_{min}$	$B(P) > B_{min}$		Constrained bandwidth
Delay	$D_{max}$	$D(P) \leq D_{max}$		Constrained delay
Packet loss	$L_{max}$	$L(P) \leq L_{max}$		Constrained packet loss
Bandwidth			$\arg \max_P(B(P))$	Widest path
Delay			$\arg \min_P(D(P))$	Least delay
Packet loss			$\arg \min_P(L(P))$	Least packet loss
Bandwidth, Delay	$B_{min}$	$B(P) > B_{min}$	$\arg \min_P(D(P))$	constrained-bandwidth least-delay
Bandwidth, Packet loss	$B_{min}$	$B(P) > B_{min}$	$\arg \min_P(L(P))$	constrained-bandwidth least-packet loss
Delay, Bandwidth	$D_{max}, B_{min}$	$D(P) \leq D_{max}$ $B(P) > B_{min}$		Constrained delay-bandwidth

There are other composite-metric routing problems which are known to be NP-Complete. These problems include [7, 9, 8, 10]:

- Multi-Constrained-Path (MCP) problems. For a given network  $G(V, E)$  where each link  $(u, v) \in E$  has  $m$  additive weights  $w_i(u, v) \geq 0, i = 1, \dots, m$ , and given  $m$  constraints of additive parameters  $C_i, i = 1, \dots, m$ , the problem is stated as finding a path  $P \in P'$  where  $P'$  is the set of all feasible paths from source node  $s$  to destination node  $d$  such that:

$$\forall p \in P', W_i(p) \leq C_i \text{ for } i = 1, \dots, m$$

where:

$$W_i(p) = \sum_{(u,v) \in p} W_i(u,v)$$

An example of the MCP problems is the constrained-delay constrained-jitter problem. The goal is to find a path such that the delay is less than the delay constraint parameter and the jitter is less than the jitter constraint parameter. It should be noted that it is possible to have multiple paths that satisfy all constraints. Any such path is considered a feasible solution for this problem.

- Multi-Constrained Optimal Path (MCOP) problems. For a given network  $G(V, E)$  where each link  $(u, v) \in E$  has  $m$  additive weights  $w_i(u, v) \leq 0, i = 1, \dots, m$ , and given  $m$  constraints of additive parameters  $C_i, i = 1, \dots, m$  and an additive cost parameter  $W_k$ , the problem is stated as finding a path  $P \in P'$  where  $P'$  is the set of all feasible paths from source node  $s$  to destination node  $d$  such that:

(a)  $\forall p \in P', W_i(p) \leq C_i$  for  $i = 1, \dots, m$

(b)  $W_k(P)$  is minimized over all feasible paths satisfying (a).

where:

$$W_i(p) = \sum_{(u,v) \in p} W_i(u,v)$$

An example of MCOP problems is the constrained-delay least-jitter problem. The goal is to find a path such that the delay is less than the delay constraint parameter and the jitter is minimized.

Table 2.2 shows a sample list of NP-Complete QoS routing problems. For these problems we have to use heuristics and approximation algorithms. Many of these algorithms were discussed in [11, 7, 9, 12, 13].

Table 2.2: Sample of NP-Complete QoS routing problems

Metrics	Params	Constraint	Optimization	Notes
Delay, Jitter	$D_{max}, J_{max}$	$D(P) \leq D_{max}$ $J(P) \leq J_{max}$		Constrained delay-jitter
Delay, Packet loss	$D_{max}, L_{max}$	$D(P) \leq D_{max}$ $L(P) \leq L_{max}$		Constrained delay-packet loss
Delay, Jitter	$D_{max}$	$D(P) \leq D_{max}$	$\arg \min_P(J(P))$	Constrained- delay least- jitter
Jitter, Packet loss	$J_{max}$	$J(P) \leq J_{max}$	$\arg \min_P(L(P))$	Constrained- jitter least- packet loss

## 2.2 Software-Defined Networking (SDN)

### 2.2.1 Early Efforts Prior to SDN

Before SDN became a trending research topic in the area of networking, several efforts that share certain similar ideas have been discussed and proposed to solve the challenges of traditional network architecture. These efforts contributed in different aspects to the currently popular SDN architectures. The ideas and concepts range from decoupling control plane and forwarding plane to achieving some level of programmability in networks [14, 15]. In this section, we will describe briefly some of these efforts.

#### Routing Control Platform

The Routing Control Platform (RCP) [16] was proposed to solve some issues with existing routing mechanism within autonomous systems (AS). The internal Border Gateway Protocol (iBGP) architecture used within AS requires full-mesh configuration which does not scale to large networks. While using a hierarchy of Routing Reflectors (RR) helps in avoiding the scalability issue, it causes problems such as protocol oscillations, persistent loops, and configuration complexity. These problems make it difficult to manage the autonomous systems in terms of

configuration changes, diagnosis and troubleshooting of forwarding errors. These problems happen because routing decisions are made by routers that do not have a complete view of the whole network

In RCP architecture, the BGP decision process is implemented in a logically centralized platform. The routing control platform is separate from the IP forwarding plane. The main goal of this platform is to perform route selection decisions centrally instead of making routers do this job. The RCP avoids the aforementioned problems by computing routing decisions based on a complete view of the whole network topology and the available routes. This information is collected using the existing protocols BGP and Interior Gateway Protocol (IGP). There are three modules in this RCP architecture: *the IGP Viewer*, *the BGP Engine*, and *the Route Control Server*. The IGP Viewer maintains an up-to-date view of the IGP topology. The BGP Engine is responsible for learning BGP routes from each router. The Route Control Server uses the information obtained from the other two modules to compute the best route for each router. After the route selection process is executed centrally, the Route Control Server communicates with routers through the BGP engine and installs new forwarding entries that correspond to the selected routes. The communication between the Routing Control Platform and routers is done through existing standard protocols (BGP and IGP) without any modification or introduction of new protocols.

### **The 4D project**

The 4D project was one of the earliest attempts to promote the initiative of decoupling the network architecture into different planes. The clean slate 4D approach to network control and management [17] proposed an extreme design principle by separating the routing decisions logic and packet forwarding. It is considered an extreme design point because the packet forwarding and the control



logic were tightly coupled in existing network devices. According to [17], the problems with the current Internet architecture is caused by the complexity of the control and management planes. This is due to the fact that the control logic and packet forwarding are bundled into distributed routers and switches. Instead of adding to previous building blocks to solve current problems, the 4D project team suggested a clean slate approach that provides an alternative perspective to the incremental evolution in computer networks.

The leading principles of this design approach focus on satisfying network-level objectives, having network-wide topology view, and providing direct control over the operation of networking devices. The proposed clean slate 4D architecture decouples networking functions into 4 planes: *data*, *discovery*, *dissemination*, and *decision* planes. The data plane is for processing individual packets based on configurable rules dictated by the decision plane. The discovery plane is responsible for gathering network topology information and other network measurements. The dissemination plane serves as a reliable communication channel between the decision plane and the data plane. It is used for installing rules on networking devices to control how packets are processed. The decision plane acts like the “brain” of the network and aims to replace the management plane in traditional network architecture. It consists of logically centralized controllers hosted on multiple servers. The main purpose of this plane is to make all decisions that manage and control the network. To do this efficiently, it makes use of the information gathered by the discovery plane (the global view of the network topology and the real-time network measurements). The output of the decision plane comes as packet-handling states that are configured in networking devices in the data plane by the dissemination plane

## Ethane

Ethane [18] is considered the direct predecessor of OpenFlow. The project continued on the previous work of SANE [19]. SANE was also a clean slate design approach focusing on enterprise security. However, SANE was difficult to deploy in the real world because it requires changing the entire networking infrastructure. Ethane mitigated this problem by supporting the incremental deployment. It does not require changing the entire infrastructure and Ethane switches can be incrementally deployed within existing network infrastructure.

The design of Ethane followed the lead of 4D project. It decouples the control plane and the data plane. It also adopts a logically centralized controller that has access to the whole network. The emphasis of this centralized controller is to enforce global network policies. The other component is a layer of Ethane switches. These switches are very simple and contain only a flow table and a secure communication channel to the centralized controller. This simple design of switches is the foundation of OpenFlow switches as we will see in the next section.

The Ethane switch forwards packets based on the matched flow table entry. If a packet was not matched by any flow table entry, which is the usual case for the first packet of any flow in this system, then it is forwarded to the centralized controller. The controller will install the appropriate flow table entries on Ethane switches. The installed flow table entries are based on analyzing the packet by the controller. The main goal of the controller is to enforce global network policies. The design objectives of Ethane (enforcing enterprise-level policies) and the size of their target infrastructure (small campus networks) make the reactive mode a reasonable design approach. However, this solution does not scale to large networks.

### 2.2.2 SDN Model

Software-Defined Networking is a new networking architecture that aims to create a breakthrough improvement of how computer networks are designed and managed. The basic concept of SDN is to separate networking functions into two different planes: control plane and data plane. Traffic control decisions are made by application programs (called controllers) in the control plane while forwarding traffic is done by networking devices in the data plane. The communication between the control plane and the data plane is done through standardized protocols. OpenFlow [20] is the most successfully implemented SDN protocol. One of the benefits of having a centralized network controller is the availability of global view of network topology and monitoring its measurements. This allows the controller to make more educated routing decisions. In the traditional network architecture, processing traffic is based on packets. Network devices make forwarding decisions using address information in data packets, but data usually is sent as a flow from host to host. Software-Defined Networking uses the flow as the basic unit for handling traffic. Figure 2.1 shows a simplified SDN architecture.

In the pre-SDN era, QoS routing decisions were mostly handled in network devices. Proposed algorithms can be grouped into three categories: source routing (which runs at the source node), distributed routing (calculating the path is distributed among multiple nodes), and hierarchical routing (routing logic and network state are distributed among clusters of nodes). The advantages and disadvantages of each approach were discussed in the literature [7]. However, the advent of SDN changes the way of handling routing decisions. Network nodes do not need to maintain a global state of the network or compute QoS routes. These tasks can be delegated to the control plane.

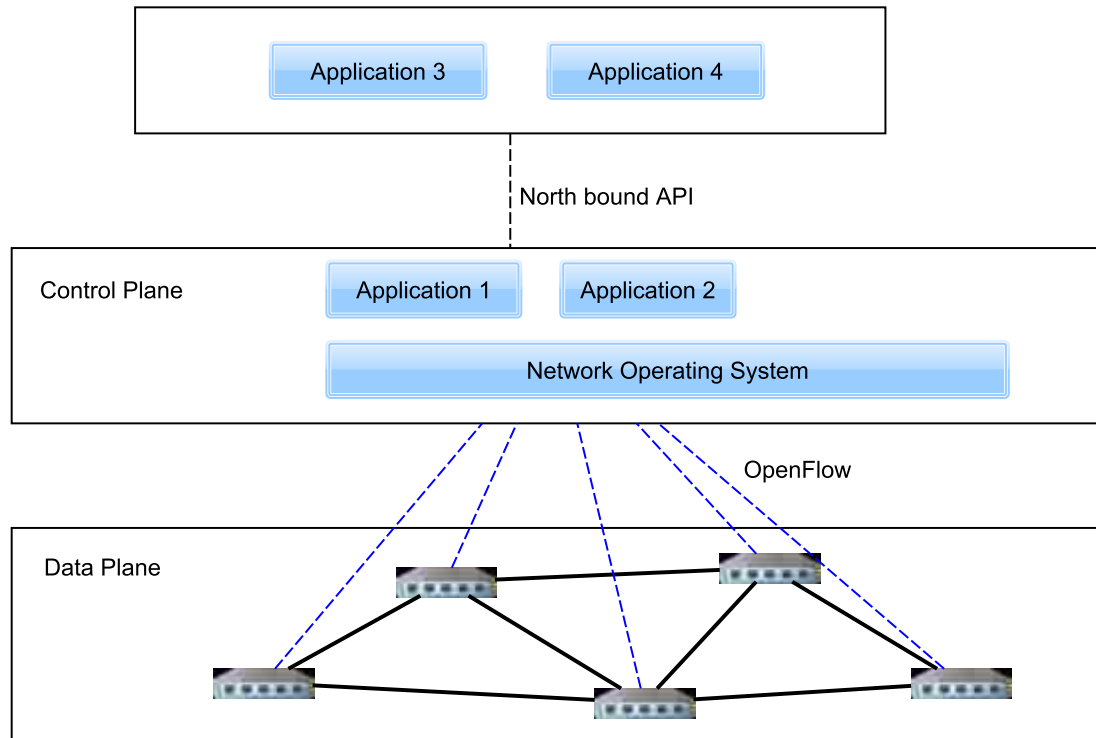

Figure 2.1: Simplified SDN architecture

### 2.2.3 SDN Characteristics

Software-Defined Networking has some distinguishing characteristics that define how it is different from the traditional networking architecture. These characteristics include [14, 21]:

- Decoupling control and forward functions. While these two functions are tightly coupled in traditional networking devices, the separation between control plane and data forwarding plane is a key feature of Software-Defined Networking.
- Logically centralized network management. The management tools and protocols are distributed in the traditional network architecture in a way that makes the management task very difficult and sometimes inefficient.

- Open standards. To promote the development of new network protocols and tools, popular Software-Defined Networking architectures are based on open standards such as the OpenFlow [20] protocol.
- Programmable network. The ability to program the network was one of the important motivations for Software-Defined Networking. Traditional network architectures provide limited support to achieve a restricted level of network programmability.
- Flow-based. In the traditional network architecture, processing traffic is based on packets. Network routers and switches make forwarding decisions using address information in data packets, but data usually is sent as a flow from host to host. Software-Defined Networking uses the flow as the basic unit for handling traffic.

#### 2.2.4 SDN Benefits

Software-Defined Networking promises many benefits for the next generation of computer networks. These benefits include [14, 21]:

- Easier management by separating network control logic from the underlying networking devices (e.g., switches, routers, middleboxes) and providing central management tools for network administrators.
- Innovation in new network protocols and tools. Using open standard protocols enables the creation of new innovative products.
- Flexibility and agility of network configurations and applying new changes in response to traffic requirements.

- Testing and deploying new network protocols and algorithms is a lot easier compared to the traditional network architectures where dedicated infrastructure is usually required for testing purposes only.
- Network function virtualization. Many network functions that are usually implemented in dedicated devices (e.g., firewalls, load balancers, intrusion detection systems, etc.) can be implemented in virtual machines.

### 2.2.5 OpenFlow

The OpenFlow [20] architecture follows the principle of separation between control plane and data forwarding plane. Initially, OpenFlow was proposed to enable researches to develop and test new network protocols and solutions on campus networks. It is currently the most popular architecture for Software-Defined Networking. Several commercial products provide support for OpenFlow architecture. The bottom layer of this architecture, the data forwarding plane, consists of OpenFlow switches. The OpenFlow switch contains at least three main components. First, one or more flow tables. Second, a secure communication channel between the switch and the controller. Third, support for the OpenFlow protocol.

The flow entries in the flow table determine how a matching packet is processed. For example, a packet can be forwarded to a specific port, encapsulated and sent to the controller, or dropped. Each flow entry is typically constructed from the following fields:

- Match fields: to define the rule packets belonging to the flow. These rules usually match information found in packet headers or port number.
- Instructions: the action associated with the rule that specifies how the packet is processed.

- Counters: statistics in the form of counters of the flow (e.g., number of received/transmitted packets and bytes, duration of the flow).
- Priority: to specify the matching precedence of flow entries.
- Timeouts: the switch when the flow entry is expired. There are two types of timeouts: hard timeout (the total time from installation) and soft timeout (the idle time).
- Cookie: A data item chosen by the controller. Cookies do not impact processing packets in the data plane. The controller can use cookies to filter flows based on different types of tasks or based on which module/application in the control plane installed them.
- flags: used for managing flow entries. For example, the flag `OFPPF_SEND_FLOW_REM` is used for sending a message to the controller when the corresponding flow entry is removed.

When a packet is received by an OpenFlow-enabled switch, its properties are matched against a set of attributes stored in records of the flow tables. If a match is found then the corresponding instructions for the table record are added to the actions list. If a packet is matched by more than one record, the instructions of the record with the highest priority are added to the actions list. An OpenFlow switch can have multiple flow tables which are processed as a pipeline. It is possible to have an instruction to direct a packet explicitly to another table. If the packet did not match any flow record it is called a table-miss. The applied actions of the table-miss depends on the configuration of the table. The packet can be encapsulated and forwarded to the controller. However, it is possible to process the non-matching packet using IP forwarding if the switch supports both OpenFlow and non-OpenFlow forwarding.

The OpenFlow protocol defines the communication between the controller and the OpenFlow switch. It contains a set of protocol messages that are exchanged between the controller and the switches over a secure communication channel. Using OpenFlow protocol, the remote controller can install, update, or remove flow records in flow table inside the OpenFlow switch. It also enables the controller to retrieve statistics. Many products and tools were developed using OpenFlow architecture.

Most of the early systems of Software-Defined Networking were designed to operate on a *reactive* mode (e.g., Ethane). In the reactive mode, the first packet of the flow is forwarded to the controller that installs new flow entries to control the remaining packets of that flow. In the *proactive* mode, systems do not require sending the first packet to the controller. Instead, the controller changes the flow entries based on other inputs like topology changes or responding to statistics. OpenFlow architecture supports both reactive mode and proactive mode. In the reactive mode there will be a performance delay since the first packet of each flow will need to go to the controller for further processing. While this performance penalty can be affordable in small campus networks, it does not provide a realistic solution for large production networks. It also increase the challenge of scalability as the controller must process larger number of packets in larger networks.

### 2.2.6 Open vSwitch

Open vSwitch [22, 23] is a software implementation of network switch that can be used in a virtualized environment. It provides connectivity between virtual machines and physical network interfaces within a hypervisor. This software switch provides support for multiple networking protocols and standards, including OpenFlow. Open vSwitch can operate like a basic L2 switch or can be integrated into a virtualized environment. To support virtualized deployment, Open vSwitch exports interfaces for manipulating forwarding tables and managing configuration states. This allows



remote processes to access and modify configurations and forwarding tables directly. Open vSwitch also exports a local connectivity management interface which allows the virtualization layer to manipulate its topological configuration. Open vSwitch can be used in creating a single logical switch across multiple Open vSwitches running on separate physical servers. It is also helpful in overcoming the limitation of virtual machine mobility between different IP subnets.

# Chapter 3

## Improving the Quality of Service for Bandwidth-Demanding Traffic Flows

### 3.1 Overview

Communication technology is one of the key enabling components of current and future applications by providing reliable and efficient two-way communication capabilities. Different applications generate large volumes of data traffic with different quality of service requirements. They can be delay sensitive, bandwidth sensitive or can be served by best-effort service. Real time control in industrial systems can be easily achieved by using dedicated networks. However, using dedicated networks is not a feasible solution in more generic network settings. The packet-switched network architecture serves multiple applications where different data traffic streams coexist with each other. New challenges faced by the existing network infrastructure and control protocols include strict time requirement, high reliability, and flexibility of control.

In this chapter, we develop a framework based on software-defined networking

for providing critical communication services. The SDN architecture is generally considered most applicable to those application domains that an administrator has complete control. Examples includes data centers, home networking, smart grid applications, distribution automation and microgrids.

We can divide data traffic into two categories. One is the traffic that does not have QoS requirements (called best-effort traffic or best-effort flows) and the other is the traffic that have one or more QoS requirements such as bandwidth, delay, delay jitter or packet loss ratio (called critical traffic or critical flows). The focus of this chapter is on providing better service for critical flows that have bandwidth demand, by dynamically setting up forwarding paths in the data plane. To that end, the control program will monitor the status of the network and direct critical flows over a better path by installing OpenFlow rules on the switches. We develop a path searching algorithm and implement it as a module for the Floodlight controller [24]. The performance evaluations show that our approach can significantly improve the throughput obtained by the critical flows, compared with the shortest path routing algorithm used in current networks.

### 3.2 Related Work

The study of the QoS routing problem for multimedia applications can be dated back to the work by Wang and Crowcroft [6]. They proved that finding a path satisfying multiple additive metrics is NP-complete. They then proposed several path computation algorithms, using either centralized source routing or distributed hop-by-hop routing.

OpenQoS [25] is a controller design proposed to provide QoS guarantee for multimedia applications. Network traffic is divided into multimedia flows and data flows. OpenQoS implements dynamic routing for multimedia traffic to place them on routes with guaranteed QoS. Data flows are handled using the traditional

shortest-path algorithm. The dynamic QoS routing is formed as the Constrained Shortest Path (CSP) problem. It is formulated as finding a path which minimizes a cost function subject to the total delay to be less than or equal to a specified value  $D_{max}$  (required by the multimedia flow). The cost metric for a link is the delay measure plus the congestion measure. The congestion measure for each link depends on the bandwidth utilization. It is set to 0 if the bandwidth utilization is less than 70%. However, in their proposal they used the hop count as the delay measure (i.e., the delay measure for all links is set to 1). While OpenFlow does not provide support for gathering delay measurements, there are methods to achieve this task, such as using probe packets. Since the CSP problem is NP-Complete, they proposed using an approximation algorithm called Lagrangian Relaxation Based Aggregated Cost (LARAC) algorithm [11] to find a good route. They implemented their QoS routing on top of Floodlight controller.

VSDN (Video over SDN) [26] is another framework that aims at providing QoS guarantee for multimedia flows in video streaming applications. It exposes some QoS APIs to be used by both sender and receiver to request QoS for video streaming. The centralized controller calculates a feasible path based on QoS requirements and keeps monitoring network resources. However, VSDN requires modifying the existing OpenFlow switches to support their proposed guaranteed service.

### **3.3 An SDN-Based Framework for Setting Up Paths for Bandwidth-Demanding Flows**

We represent the network as a directed graph  $G(V, E)$ , where  $V$  is the set of all OpenFlow switches and end hosts in the data plane and  $E$  is the set of all links between these nodes. Links are represented as ordered pairs. For example,  $(v_1, v_2)$  represents the single link in the topology where  $v_1$  is the source node and  $v_2$  is the destination node. Each link is assigned the attribute of computed available capacity.

Note that the attributes can be different for links  $(v_1, v_2)$  and  $(v_2, v_1)$  because of asymmetric links.

We formulate the problem as finding the shortest path from a source node  $s$  to a destination node  $d$  such that the minimum available capacity of path links is larger than the required capacity for the critical traffic flow.

We develop two modules (*Status Monitoring* and *QoS-based Path Setup*) for the Floodlight controller, as shown in Figure 3.1. Floodlight offers a flexible module loading system that allows extensions. The basic modules of the floodlight interact with the OpenFlow switches. The extension modules can use the functionalities provided by basic modules. The first extension module is *Status Monitoring*, which collects network measurements as a basis for the second module. They include usage information, such as used bandwidth, for each link. The second extension module is *QoS-based Path Setup*, which calculates a path using the topology of the network graph and collected measurements. It finds a path that satisfies a specific bandwidth requirement and installs OpenFlow rules on the switches in the data plane.

### 3.3.1 Status Monitoring

The OpenFlow switch specification [27] defines a list of counters that must be supported by OpenFlow-capable switches. The list includes per-flow counters and per-port counters. We are interested in the per-port counters, specifically the transmitted bytes counters. The controller can retrieve the values of these counters by sending a statistics request message to the switch and getting a reply message that contains the number of transmitted bytes at the time of the request. It should be noted that these measurements will not be 100% accurate by the time the controller receives them, due to the delay of the request-reply messages and the processing delay at the controller. Nonetheless, they give a good estimate of the usage of the links being monitored.

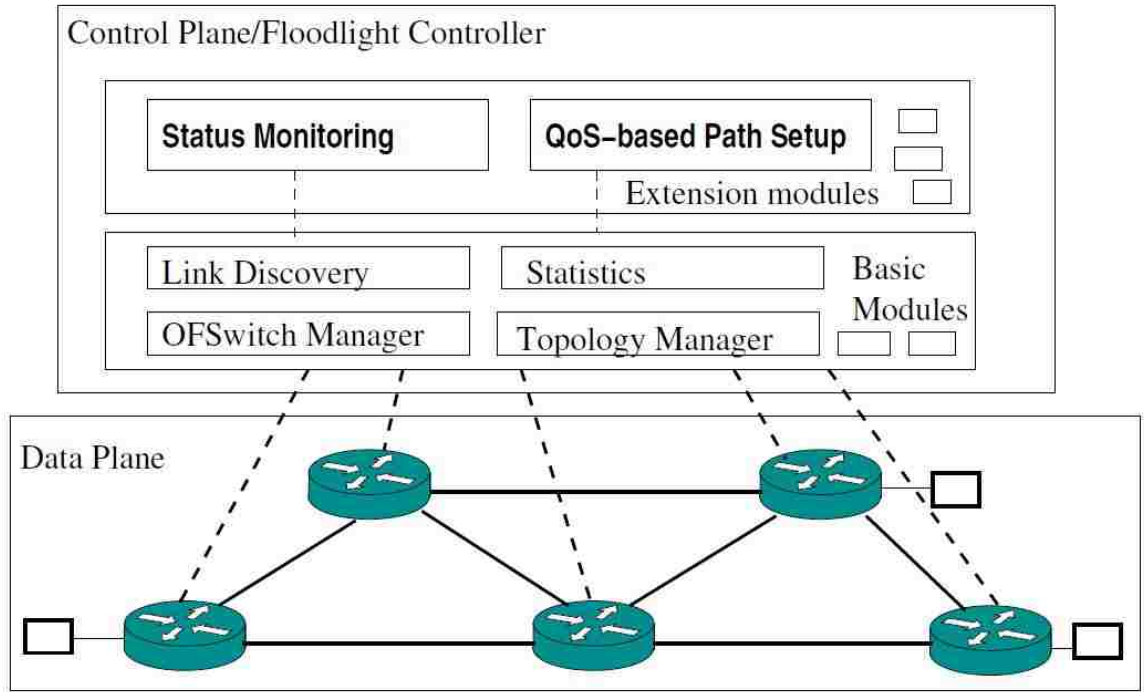

Figure 3.1: The SDN architecture for providing QoS support

The controller application collects statistics measurements (counters of transmitted bytes) periodically. Each link in the network topology has a source switch-port and/or a destination switch-port. The used bandwidth of a link is obtained by dividing the number of transmitted bytes from the source switch-port of that link over the time interval <sup>1</sup>. The difference between the values of two consecutive reply messages for the switch-port counter is used to calculate the consumed bandwidth of the corresponding network link. The OpenFlow specification does not include timestamps for measurements reply messages. Hence, the time interval is set at the control plane level as the difference between the timestamps of sending these requests to the switch. The time interval should be chosen carefully. It has to be small enough so that the calculated bandwidth is relatively up-to-date. It also cannot be too small; otherwise the controller and

<sup>1</sup>Another approach is to use the received bytes counter of the destination switch-port.

switches will be burdened by the overhead of processing these messages. An interval between 5 and 10 seconds is a reasonable choice.

We obtain network topology information from Floodlight module *topology manager*. For each link we subtract the calculated bandwidth from its maximum capacity to get the available capacity used in the routing algorithm. To get the maximum capacity of the link, the controller can send a request to the switch asking about the features of a port (or multiple ports) in the switch. The advertised port capacity is one of the port features.

### 3.3.2 QoS-based Path Setup

There are many measures to specify different aspects of QoS requirements. In this chapter, we only consider the traffic flows demanding bandwidth requirement. These flows, which we call them critical flows, must be placed on network paths that have sufficient bandwidth capacity, while the non-critical flows are handled as best-effort and routed using the shortest-path algorithm. The critical traffic can be distinguished from best-effort traffic by matching packets from the flow against a set of fields. OpenFlow defines a list of match fields that can be used to differentiate between flows. The list of required fields that must be supported by OpenFlow switches include Ingress port, source and destination MAC addresses, MAC type, source and destination IP addresses, protocol type, and transport layer ports (see Figure 3.2). There are other fields stated in the OpenFlow specification, but switches are not required to support all of them. A flow can be identified by setting match rules against any number of these fields. For example, we can define critical traffic to be all TCP traffic from a specific IP address, or all TCP traffic within a pre-defined source port range.

The first packet of each flow is encapsulated inside a PACKET\_IN OpenFlow message and forwarded to the controller. This implies that the controller processes

L1	Ingress Port
L2	Ethernet source    Ethernet destination    Ethernet type
L3	IPv4/IPv6 protocol number    IPv4/IPv6 source    IPv4/IPv6 destination
L4	TCP/UDP Source Port    TCP/UDP destination Port

Figure 3.2: Match fields in OpenFlow

the first packet and then installs forwarding rules to handle the remaining packets of the same flow. Our module listens for `PACKET_IN` messages and processes the packet encapsulated within the received messages. To determine the flow type, the packet is decapsulated to extract IP addresses, or TCP ports (if it is a TCP packet) depending on what was defined as critical flows. They are then compared to the predefined addresses or ranges. If it is critical traffic, the route calculation module tries to place the flow on a route that satisfies the bandwidth requirement. Otherwise, it is considered non-critical traffic, which is routed as best-effort traffic and handled by the Floodlight *forwarding* module that uses Dijkstra's algorithm to calculate the shortest path.

The method for finding the QoS path for a flow is described in Algorithm 1. It traverses the network graph to search for the destination node. Along the way, it bypasses the links that have available capacity less than the required capacity by the critical flow. The available capacity is calculated and updated periodically to reflect the current status of the network. If the destination node is reached, the search stops and constructs the path for the critical flow. It should be noted that this path is not necessarily the widest path (with the highest available capacity), but it is the shortest path with sufficient available capacity. This decision is made with the consideration of reducing the number of hops along the path, which will reduce the utilization of



network switches and (in most cases) reduce latency.

After the path is found, corresponding OpenFlow rules will be generated and installed by the Floodlight controller to the switches along the path. If the search fails to find a path that satisfies the required bandwidth capacity it returns *null*. In this case, the critical traffic flow cannot be placed on a route that meets its requirement. Instead, it will be handled like normal traffic and forwarded along the shortest path using Dijkstra's algorithm.

We implemented the QoS routing algorithm as a module inside the Floodlight controller [24]. Floodlight is Java-based controller that was forked from Beacon [28], one of the first OpenFlow controllers. Floodlight offers a flexible module loading system that allows extensions. There are two methods for writing applications on top of Floodlight controller. First, the application can be written in Java as an embedded module inside Floodlight. It can communicate with other built-in modules and consumes the provided services directly. Second, an application can be written in any language and communicate with Floodlight using REST APIs. It can retrieve information and invoke services by utilizing the exposed Floodlight REST APIs. We chose to implement the QoS routing algorithm as a Java module inside Floodlight. If someone wants to develop an application that is large and performs computationally expensive actions, then it would be more suitable to write it as a separate application that can run on a different server and communicate with Floodlight using its exposed REST APIs.

---

**Algorithm 1** FindQoSPath(source, destination, reqCapacity)

---

```
queue ← empty
visited ← empty
prevLink ← empty
queue.add(source)
visited.add(source)
dstFound ← false
while (queue is not empty) and (dstFound = false) do
    node ← queue.remove()
    for link ← topologyLinks.connectedto(node) do
        neighbor ← link.getDestination()
        if visited.contains(neighbor) then
            continue
        end if
        if getAvailableCapacity(link) < requiredCapacity then
            continue
        end if
        queue.add(neighbor)
        visited.add(neighbor)
        prevLink[neighbor] ← link
        if neighbor = destination then
            dstFound ← true
            break
        end if
    end for
end while
if dstFound = true then
    route ← empty
    node ← destination
    while (node ≠ source) do
        route.addFirst(prevLink[node])
        node ← prevLink[node].getSource()
    end while
    return route
else
    return null
end if
```

---

## 3.4 Evaluation

### 3.4.1 First Experiment

#### Experiment Setup

For testing the QoS routing algorithm we used Mininet [29] with the software Open vSwitch [22]. Mininet is an emulation tool that provides a virtualized environment for prototyping and evaluating SDN applications. It uses lightweight virtualization techniques at the operating system level to emulate hosts, links, switches, and controllers. We wrote Python scripts using Mininet Python APIs to create the network topology. Mininet can be configured to work with software switches. We chose Open vSwitch due to its flexibility and good support for OpenFlow switch specification.

To test our QoS routing module, we created a network topology with 8 switches (Open vSwitch) and 22 hosts in Mininet. The topology is shown in Figure 3.3. The bandwidth of the links between switches is set to 25 Mbps and the bandwidth of the links between switches and hosts is set to 10 Mbps. Mininet uses the traffic control command in Linux *tc* to specify the bandwidth. After that, we generated 14 flows using *iperf3* [30]. Five of these flows were critical flows. Table 3.1 shows the list of flows in this experiment. Using Python script, we started the Mininet topology and then generated the flows in the order shown in the table. The Floodlight controller was running on a different machine connected to the Mininet host.

#### Results

First, we ran this experiment with QoS routing module disabled in Floodlight. Then we ran the same experiment with QoS routing module enabled. Since the link between switches and hosts has the capacity of 10 Mbps, the maximum speed a critical flow can send is 10 Mbps. The measured throughput for each flow in both cases is shown

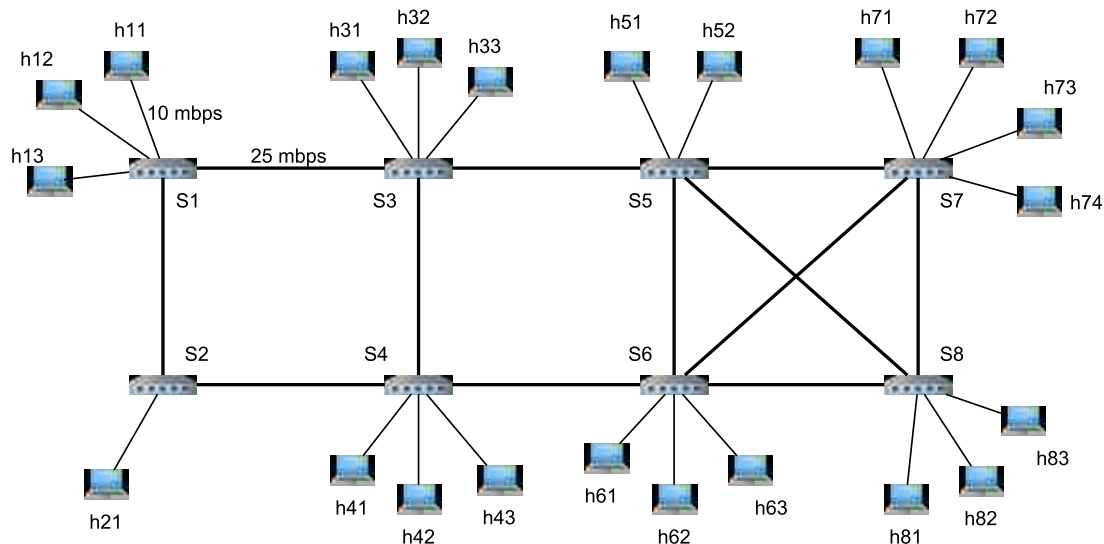

Figure 3.3: First experiment topology in Mininet

Table 3.1: Traffic flows

Flow	Source	Destination	Start time	Is Critical	Size
1	h31	h42	2	No	150 MB
2	h41	h32	3	No	140 MB
3	h32	h41	4	No	145 MB
4	h42	h31	7	No	135 MB
5	h11	h71	22	Yes	135 MB
6	h71	h61	23	No	140 MB
7	h43	h33	25	No	120 MB
8	h33	h81	41	Yes	130 MB
9	h74	h63	42	No	115 MB
10	h12	h51	57	Yes	125 MB
11	h72	h62	59	No	125 MB
12	h51	h83	76	No	100 MB
13	h13	h82	91	Yes	120 MB
14	h73	h21	106	Yes	110 MB

in Figure 3.4.

The experiment results show that all five critical flows achieved much smaller throughput when the Floodlight controller was running without the QoS routing module. The average rates for critical flows were 8046 kbps (flow No. 5), 7248 kbps

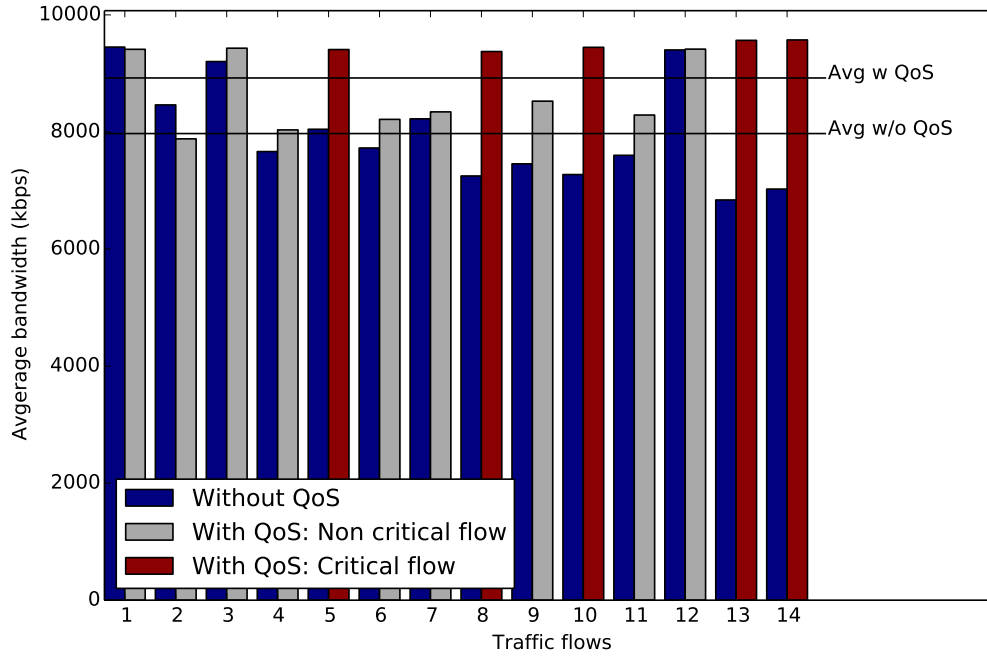

Figure 3.4: Throughputs with five critical flows

(flow No. 8), 7272 kbps (flow No. 10), 6838 kbps (flow No. 13), and 7024 kbps (flow No. 14). The measurements improved in the case with the QoS routing module enabled. The throughputs for critical flows were 9408 kbps (flow No. 5), 9374 kbps (flow No. 8), 9446 kbps (flow No. 10), 9565 kbps (flow No. 13), and 9572 kbps (flow No. 14).

Figures 3.5 and 3.6 show the measured throughput for each critical flow as reported by iperf3 with an interval of 10 seconds. The x-axis denotes the lifetime for each flow (its duration), not the time for the experiment. In the first experiment, flow No. 10 (from  $h_{12}$  to  $h_{51}$ ) was routed through  $S1$ ,  $S3$ , and  $S5$ . Link ( $S3$ ,  $S5$ ) already had 2 flows (No. 5 and No. 8), leaving it with about 5 Mbps capacity. Using this route caused the link to be congested. When the QoS routing module is enabled, the throughputs of all these critical flows have been improved, as shown in Figure 3.6. The QoS routing module placed flow No. 10 on a different route ( $S1$ ,  $S2$ ,  $S4$ ,  $S6$ ,

S5). This placement allowed all three flows to have better throughput. From the figure, we can see that there is little variation and the throughputs of these critical flows stay constantly around 9.5 Mbps.

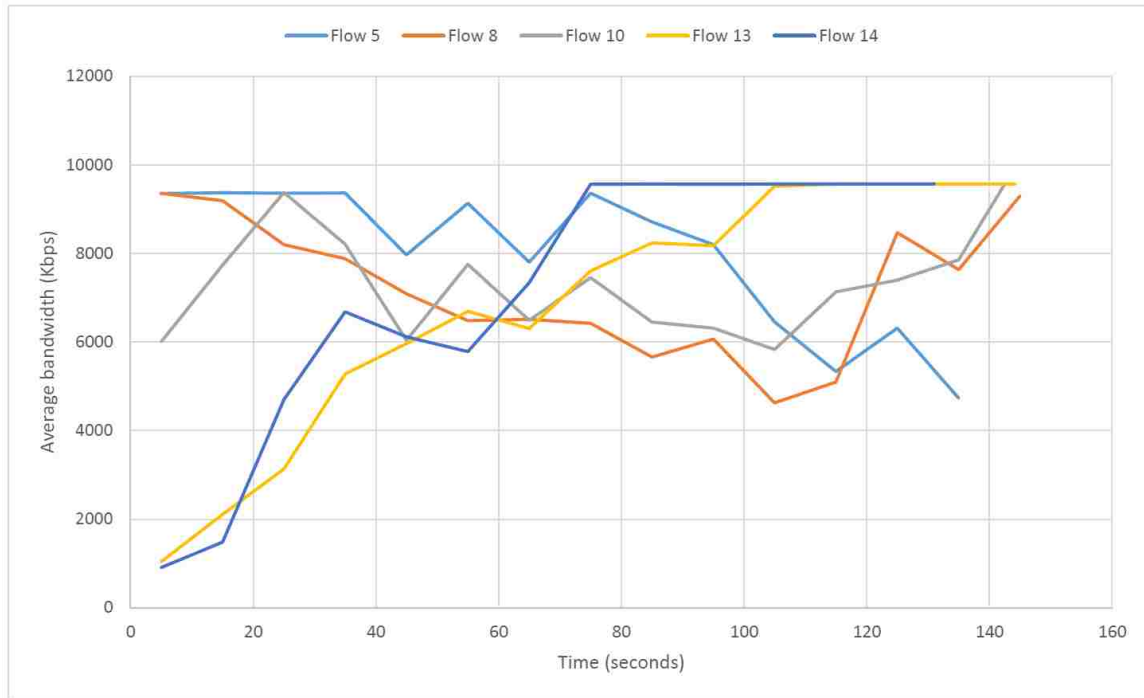

Figure 3.5: Throughputs for critical flows without QoS routing module

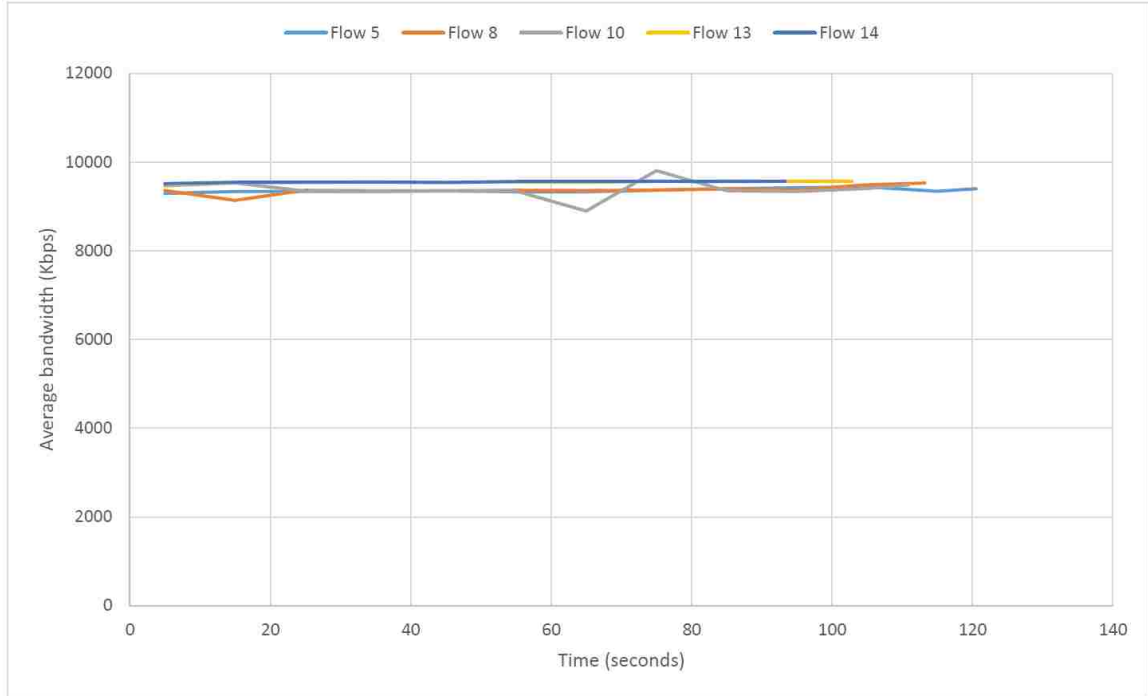

Figure 3.6: Throughputs for critical flows with QoS routing module

To show the difference of handling a flow based on its type, we conducted the same experiment after changing flow No. 11 (from  $h72$  to  $h62$ ) to be a critical flow. In the two previous experiments, this flow was placed on path ( $S7, S6$ ) and its throughput was about 7600 kbps. After this change, the same flow was placed on path ( $S7, S8, S6$ ). The measured throughput for this flow was 9571 kbps. This change also improved the throughput of other flows as shown in Figure 3.7.

The benefits of avoiding congested links include better utilization for network-wide bandwidth. This is illustrated in Figure 3.8. Results were obtained from three runs of the experiment, i.e., without the QoS module enabled, with the QoS module enabled with 5 critical flows, and with the QoS module enabled with 6 critical flows. It shows that when the QoS module was enabled, the network achieved higher levels of utilization.

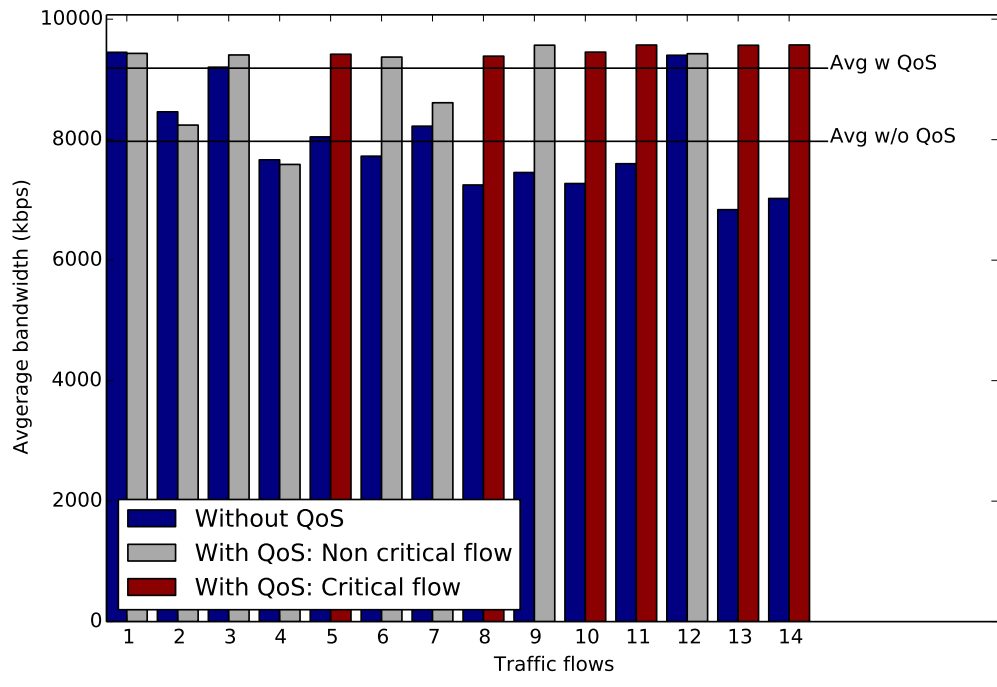

Figure 3.7: Throughputs with six critical flows

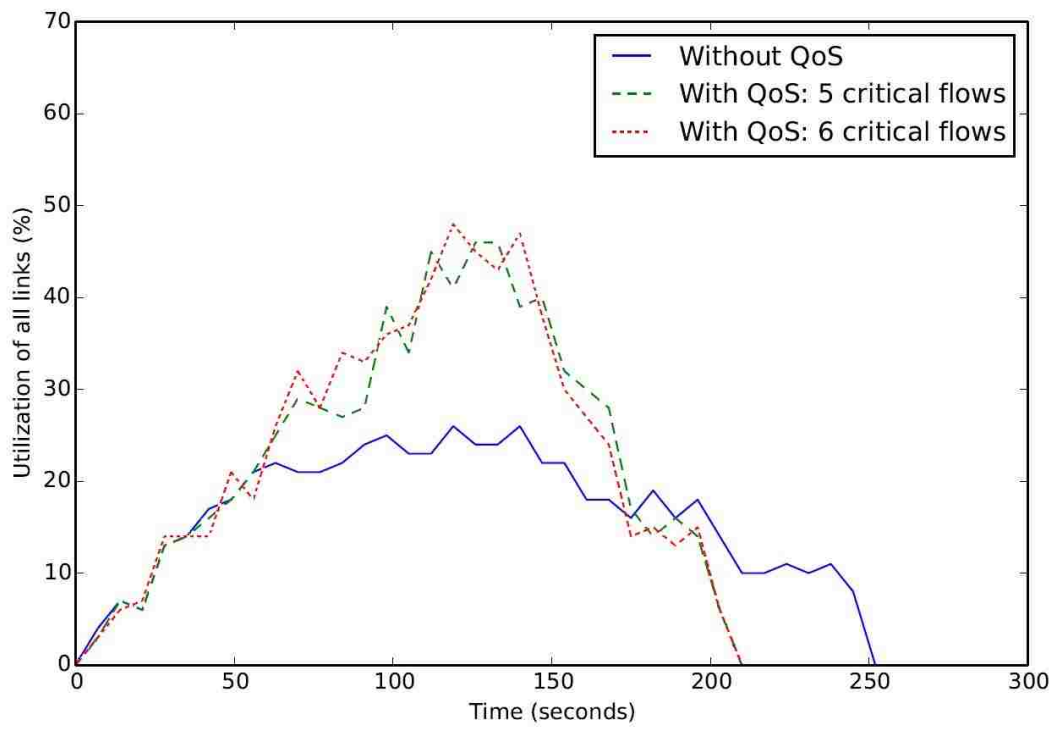

Figure 3.8: Utilization of the whole network



### 3.4.2 Second Experiment

#### Experiment Setup

In the previous experiment, the QoS routing module was able to find a feasible path for all critical flows. Which means all critical flows were *accepted* by the module. However, this is not always the case. Sometimes the network becomes congested in a way that prevents finding a path with sufficient capacity. In the second experiment, we want to measure the overall performance of the network in relation to the number of accepted flows. We created a different topology of 5 switches and 20 hosts. Each switch is connected to four hosts. The bandwidth of the links between switches is set to 15 Mbps and the bandwidth of the links between switches and hosts is set to 10 Mbps. The topology is shown in Figure 3.9. We generated a random list of 20 traffic flows such that:

- Each host will send and receive only one flow.
- Source and destination switches are different for each flow.
- Start time and duration are random (within a range).
- All flows are critical.

#### Results

This experiment was repeated 30 times, each time with a different list of flows. For each time, we measured the total average throughput of all flows and the average throughput of the accepted flows. Figure 3.10 shows the obtained results. We can see clearly that as the number of accepted flows increase, the average throughput of all flows increase. Moreover, the average throughput of accepted flows is more than that of all flows.

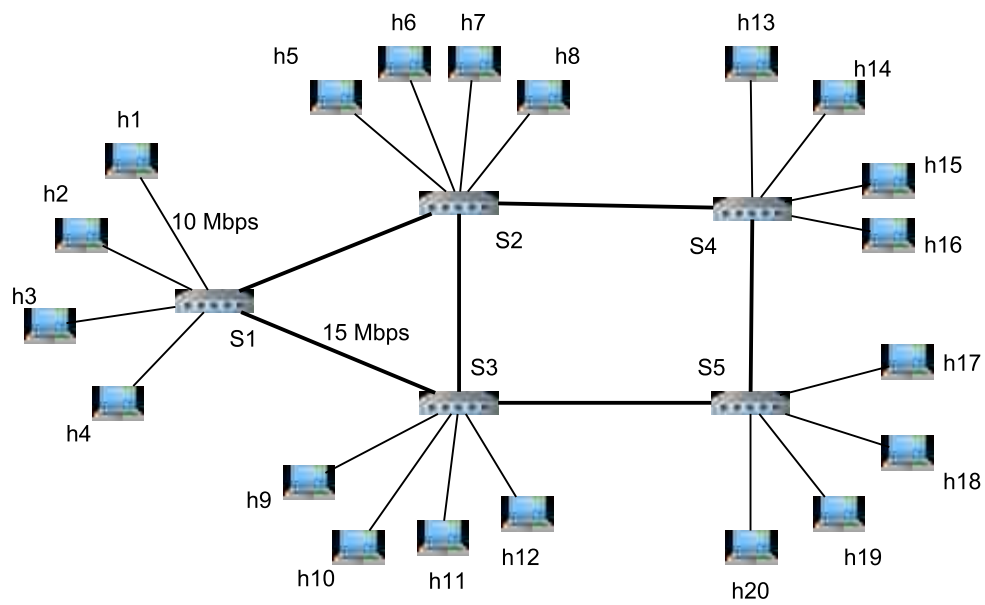

Figure 3.9: Second experiment topology in Mininet

### 3.5 Summary

In this chapter, we proposed an SDN-based framework for providing better service for critical flows. This framework focus on satisfying the bandwidth demands of critical flows. It took advantage of the SDN paradigm by developing modules in the controller to monitor the network and set up QoS paths for bandwidth-demanding flows. The evaluation results demonstrated that the new modules can improve the performance for those applications using critical flows.

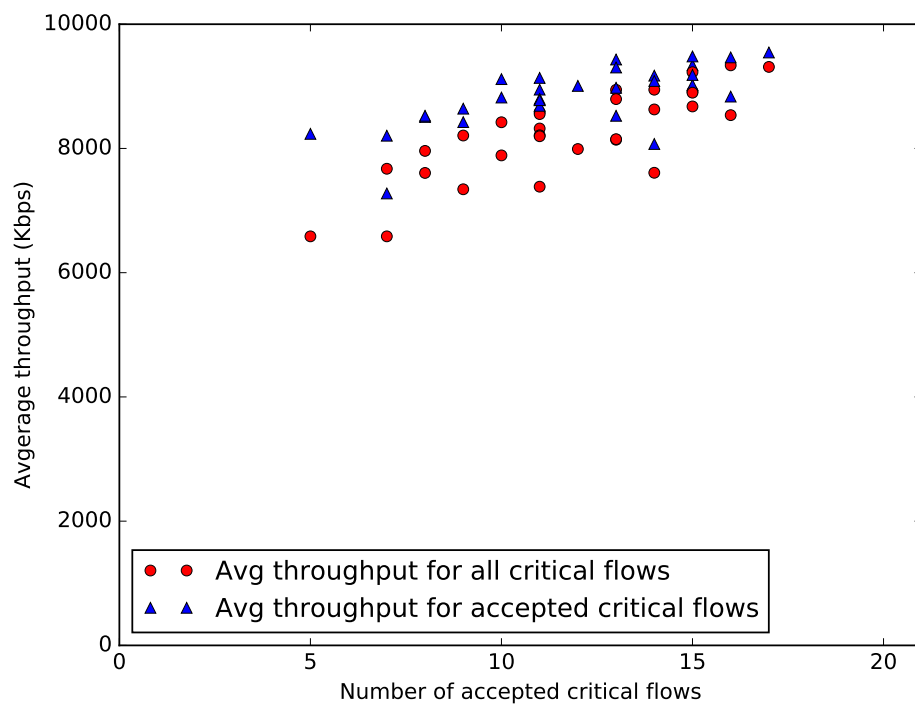

Figure 3.10: Average throughput to the number of accepted flows

# Chapter 4

## Provisioning Quality of Service to Latency-Sensitive Traffic Flows

### 4.1 Overview

Modern computer networks accommodate heterogeneous applications that have different levels of Quality-of-Service requirements. Some of network traffic flows have tight deadlines where slight increases in latency can affect the overall performance of the application. Such traffic flows need to be forwarded with higher priority than other traffic. Planning and designing networked systems that are able to efficiently provide latency guarantee remains a challenge. In this chapter, we propose a system designed for provisioning QoS to latency-sensitive traffic flows using the SDN approach. This system provides convenient mechanisms for defining, managing, and forwarding different classes of traffic flows with different levels of priorities.

#### 4.1.1 Motivation

In recent years there has been an increasingly growing interest in cloud computing and virtualized environments. This is motivated by the need for efficient utilization

of computing resources and reducing costs. Such infrastructure usually hosts various kinds of applications for different clients. Each application/client has its own set of requirements, typically defined in their Service Level Agreements (SLAs). Quality-of-Service (QoS) requirements include end-to-end bandwidth and latency among other attributes, as we discussed in previous chapters. Several efforts have been made to address the challenges of providing QoS to various types of network applications on different environments using various protocols and techniques. Provisioning and monitoring QoS in cloud computing is even more difficult due to the complexity of its shared infrastructure environment. It is common that many service providers resort to over-provisioning network resources to meet QoS requirements. However, over-provisioning is not an optimal solution. Efficient utilization of network resources requires maximizing obtained performance while reducing operational and capital costs.

End-to-end latency is an important QoS measure for certain types of network applications. For example, teleconferencing, voice-over-IP (VoIP), and online Internet gaming are typically sensitive to high latency. They require that transmitted data must have end-to-end latency below a specific threshold. If the latency exceeds this threshold it will degrade the performance and affect Quality-of-Experience (QoE) for the end user (e.g, interruptions in VoIP calls). Another example, which can have higher priority, is the control traffic which must be transmitted with least queueing delay. Different network applications have different levels of priorities which must be considered by network devices when forwarding packets. Additionally, the maximum latency requirement varies for different applications. Such network traffic must be identified and forwarded according to its respective policy. However, other network traffic (such as FTP traffic) can be more tolerant to higher latency and intermittent decrease in throughput. Such traffic can be forwarded on best-effort basis without noticeable performance degradation.

QoS requirements for latency-sensitive traffic differ depending on the application type. The ITU-T<sup>1</sup> recommends that in general network planning, a maximum of 400 ms for one-way latency should not be exceeded [1]. However, they note that many interactive applications (e.g, voice calls, video conferencing, interactive data applications) are affected by much lower latency. The experiences of most applications are generally considered acceptable if the latency is kept below 150 ms. As the traffic latency increases, the impact on applications' experiences becomes noticeable. When the latency exceeds 400 ms, most applications will encounter unsatisfactory performance.

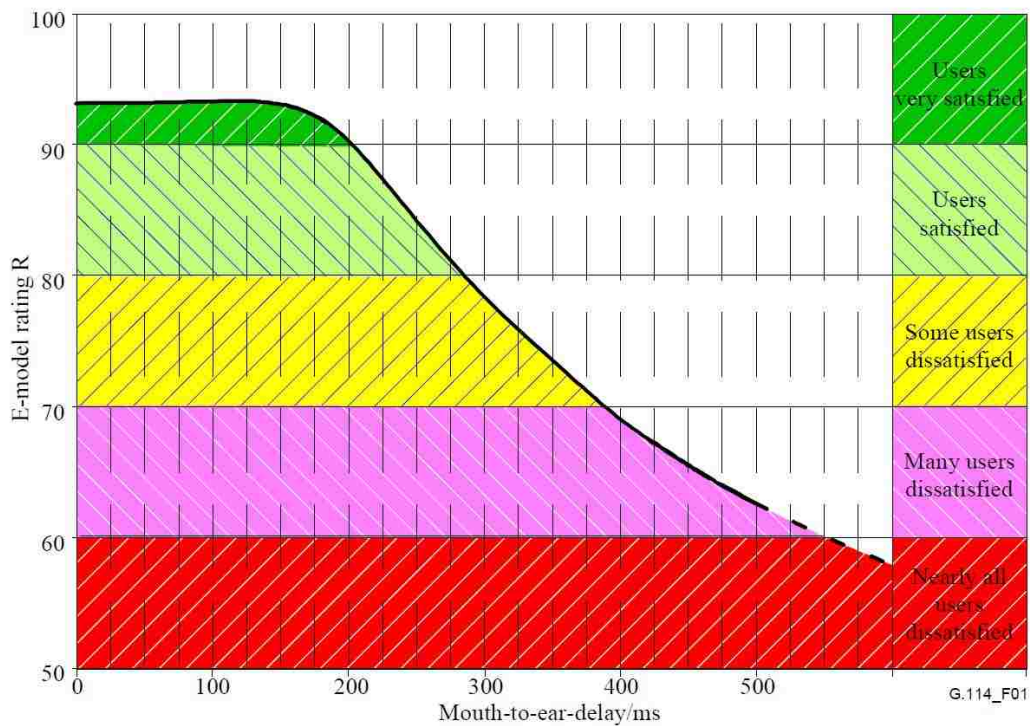

Figure 4.1: Effects of the total delay on user satisfaction (reprinted from [1])

<sup>1</sup>The ITU-T is the Telecommunication Standardization Sector of the International Telecommunication Union (ITU) which develops international standards for telecommunications. (<https://www.itu.int/>)

Several factors affect the end-to-end latency of transmitted data packets. They include:

- Processing delay. The time taken by network devices to process the packet. In ideal situations, the processing delay is negligible if packets are processed at the line rate. However, processing can involve inspecting and modifying some fields of the packet (e.g., marking DSCP field). Additionally, it can involve even more expensive tasks like deep packet inspection (DPI). Such computationally expensive tasks lead to a considerable processing delay.
- Transmission delay. The time needed by the router/switch to push all packet bits into the network link. Transmission delay is affected by link bandwidth and packet size.
- Propagation delay. The time taken by a single bit to travel through the link from the source to the destination. Propagation delay is affected by the link type and distance.
- Queueing delay. The total waiting time for a packet to stay in queues of routers and switches. Queueing delay is affected by queue size at the arrival time of the packet. It is also affected by the differential processing of data packets (i.e., higher priority traffic will spend less time in the queue compared to lower priority traffic).

To reduce the latency of traffic flows, service providers can employ techniques like resources reservations and/or QoS-aware routing. Providing a guaranteed minimum rate (bandwidth) for a flow ensures that all packets that arrive at the same rate (or below) will be forwarded without delay. However, if the arrival rate exceeds the guaranteed minimum rate then packets might have to wait in the queue for a period of time. Policies can also include a maximum rate to ensure that flows do not exceed a specific bandwidth.

We note that most traffic patterns are bursty in nature. For example, an HTTP session starts with downloading HTML page and associated multimedia objects (e.g., style sheets, images, etc.) then it becomes idle for a period of time until the user requests another HTML page. The inconsistency in traffic levels is very common even among established long-running TCP connections. The reason is because TCP congestion control adjusts the sending rate based on congestion signals to adapt to the current network conditions. It follows the mechanism additive-increase multiplicative-decrease (AIMD) which aims to preserve TCP friendliness and fairness to other traffic flows. From this perspective, we can see that if such traffic flows were assigned a guaranteed bandwidth (quota) then it is highly likely that there will be unused spare bandwidth from this quota at a given point in time.

Latency-sensitive traffic patterns can be also bursty. We direct our attention to traffic flows that do not constitute a significant portion of the total traffic in the network. Such traffic flows are not transmitted with a consistent high rate all the time. Therefore, their guaranteed minimum bandwidth (if reserved) is not used during their idle time. However, when such traffic flows are transmitted they are not tolerant of high latency. They need to be forwarded with higher priority on paths that guarantee a maximum latency less than or equal to their specified latency requirement. From this point, we realize the importance of managing priorities, guaranteed minimum rate, maximum rate, and utilizing the unused guaranteed rate for different classes of network traffic flows.

In this chapter, we propose a technique that is designed to provision and monitor quality of service to latency-sensitive traffic flows using an SDN approach. The system provides convenient mechanisms for defining and managing traffic classes in the control plane. Each class has two properties:

- Defining characteristics: which contain a unique class name and a list of all flows belonging to this class. Each flow is represented with a set of OpenFlow



match rules.

- QoS attributes: which contain class priority and optionally the minimum rate, the maximum rate, and required latency.

#### 4.1.2 Latency Measurements in SDN

Measuring latency in SDN has been discussed in the literature. For example, OpenNetMon [31] injects probe packets into the source switch of each link and install rules that make them traverse the link to be measured. The destination switch is configured to send probe packets back to the control plane. The process involves also estimating the latency between the controller and each switch by injecting packets that are returned back immediately to the controller which uses the round-trip time (RTT) to determine the latency. The monitoring application in the controller calculates the estimated latency of each monitored link. The link latency is calculated by subtracting the estimated controller-to-switches latencies from the difference between departure time and arrival time.

$$Latency = Time_{Arrival} - Time_{Sent} - \frac{1}{2}(RTT_{source} + RTT_{destination})$$

Floodlight [24], a popular SDN controller, uses a similar mechanism to calculate an estimated latency value for each link in the topology. The link discovery module encapsulates timestamps with LLDP packets using the optional type-length-value (TLV) structure. It periodically sends LLDP packets through all available ports. The link latency is smoothed by calculating the average of a specific number of latency measurements. The calculated latency is stored as attribute for each link in the discovered topology.

### 4.1.3 Queueing Disciplines

Queueing discipline (also known as *qdisc*) controls how packets are processed while waiting in the queue. The type of queueing discipline has direct influence on the latency as it determines how long the packet will have to wait before being served (transmitted). We limit our discussion to queueing disciplines that are available in Linux. The simplest type of queueing discipline is the *first-in first-out* (FIFO) *qdisc*. It ensures that the first packet to arrive will be transmitted before subsequent packets regardless of any other considerations. Although FIFO *qdisc* provides a straightforward and fast implementation, it does not enable any differential treatment for data packets. Therefore, it is not suitable for provisioning QoS. Additionally, using FIFO *qdisc* does not provide fair service to multiple traffic flows. This is because some large flows can fill the queue buffer quickly which will cause packets dropping of other flows. This unfair service pattern triggered the need for different queueing disciplines that provide fair service to multiple flows.

The *stochastic fair queuing* (SFQ) *qdisc* is an implementation of fair queueing [32]. It aims to serve all traffic flows equally by creating several queues and then, using hashing, maps packets to queues. A level of fairness is achieved by transmitting from each queue in a round-robin manner. Both FIFO and SFQ are classless queueing disciplines. That is, it is not possible to provide different service for different classes of traffic flows.

The *hierarchical token bucket* (HTB) [33] is a classful *qdisc* that was proposed to replace a previous classful queueing discipline called *class-based queueing* (CBQ) *qdisc* in Linux systems. HTB allows arranging different classes of traffic flows into a hierarchical structure. While HTB is mostly used for bandwidth guarantee, our SDN-based system utilizes it for latency-sensitive QoS provisioning. Queues can be configured by Linux *tc* command. The software switch Open vSwitch [22] provides support for HTB *qdisc*, although it does not cover all its features. Open vSwitch

allows configuring HTB queues either by command line interface (CLI) or by OVSDB protocol. We will discuss HTB qdisc in the next sections.

The *hierarchical fair-service curve* (HFSC) [34] is another classful qdisc available in Linux. HFSC also provides the ability to create a hierarchical structure of different traffic classes. HFSC aims to provide guaranteed service for both bandwidth and delay parameters by maintaining a *service curve* for each parameter. Open vSwitch allows creating queues based on HFSC qdisc. However, the delay parameter is not supported by Open vSwitch.

## 4.2 Related Work

Wallner and Cannistra [35] proposed a method for providing QoS in SDN. It involves using traffic shaping (rate limiting). Network traffic is classified using Differentiated Services Code Point (DSCP) value in the DiffServ field in the IP header. The QoS module (implemented in Floodlight) manages classes of traffic and their associated DSCP values. It handles QoS policies and manipulates flow tables. Based on traffic class, the module uses enqueue action in OpenFlow 1.0 to forward traffic using the pre-configured queues in Open vSwitch. The benefits of this solution are limited since it requires having all queues set up on switches in advance and does not implement dynamic routing.

QueuePusher [36] is a queue management extension for SDN controller that allows applications to manipulate queues in Open vSwitch nodes. It is implemented as a module for Floodlight controller. The QueuePusher module exposes basic queues operations (create, read, update, and delete) to other programs through northbound REST APIs. These basic operations can be used as basis for creating SDN-based QoS applications.

Capa and Soler [37] proposed a similar QoS configuration module for Floodlight controller. They implemented a subset of OVSDB protocol to manage queues in

Open vSwitch. Their APIs can be consumed by other internal Floodlight modules using JAVA or by external applications using REST APIs.

### 4.3 An SDN-based Architecture for Supporting Latency-Sensitive Flows

In this section, we present our proposed approach for provisioning QoS to latency-sensitive traffic. The proposed system focuses on accommodating different classes of traffic flows. It makes use of SDN architecture and HTB queueing discipline. In our approach, latency-sensitive flows are grouped into classes. Each class contains information that specify how its flows are forwarded.

The SDN-based system consists of the following components:

- **Admission control module:** responsible for handling new QoS requests. Depending on the nature of the requirements and the available resources, new requests are either accepted or rejected.
- **QoS provisioning module:** responsible for configuring queues and installing OpenFlow rules to provide the required service for accepted QoS requests.
- **QoS monitoring module:** retrieves and presents statistics about active QoS classes.
- **OVSDB agent module:** translates queue setup commands into OVSDB protocol messages.

#### 4.3.1 Admission Control

The admission control is responsible for handling new QoS requests. It is accessible through REST APIs for authorized applications. Additionally, system administrators can access a web interface for adding new requests. The new request is expected to specify the priority of the traffic class. Priority is expressed as an integer value

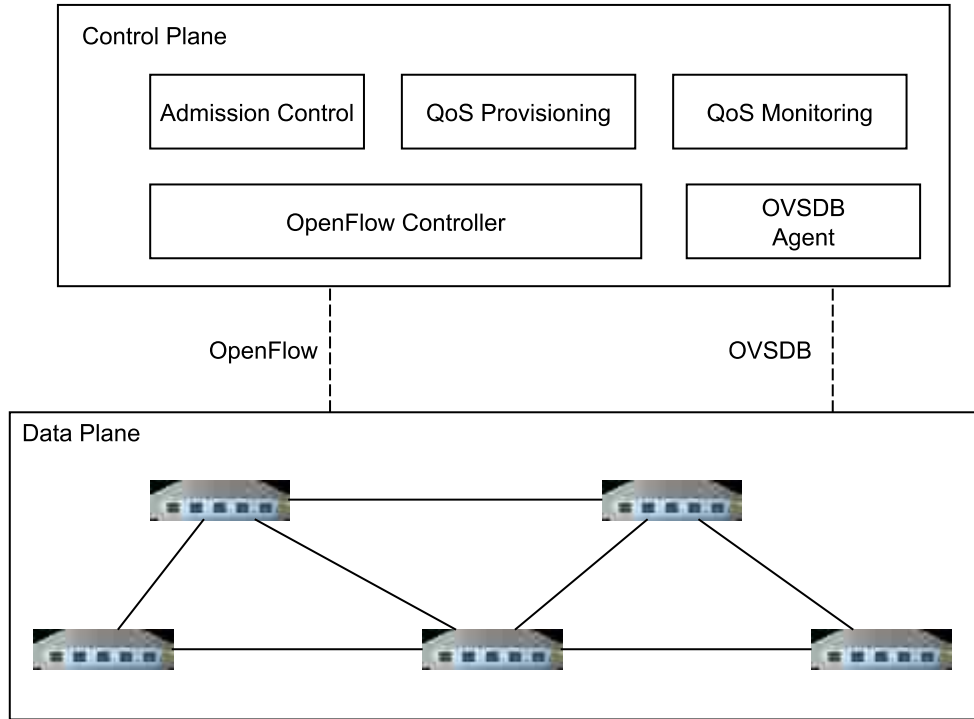

Figure 4.2: Provisioning QoS architecture to latency-sensitive flows

between 0 (highest priority) and 7 (best-effort). The request can optionally specify the minimum rate and maximum rate that will be reserved at each node along the path. These two attributes are not mandatory, and if absent their values will be assigned from default configurations:

$$minimum\_rate = quota * link\_capacity$$

$$maximum\_rate = link\_capacity$$

If the new request contains specific value for required latency (in ms) then the admission control will retrieve the measured latency for the shortest path between source and destination hosts and compare it with required latency. It rejects the request if it cannot be fulfilled (i.e., if the measured latency of the shortest path is larger than the requested latency). However, it is possible that the request does not

contain a specific latency. Rather, it just specifies the class priority. In this case, the request is accepted and added to the list of active classes if the minimum rate can be reserved at each node along the path. Otherwise, the request is rejected.

The following is an example of a new QoS request in JSON format:

---

```
{ "name": "VoIP",
  "min_rate": "2000000",
  "max_rate": "10000000",
  "latency": "150",
  "priority": "2",
  "flows": [{"ipv4_src": "10.0.0.2",
             "ipv4_dst": "10.0.0.4",
             "tcp_src": "5001"},
            {"ipv4_src": "10.0.0.4",
             "ipv4_dst": "10.0.0.2",
             "tcp_dst": "5001"}]
}
```

---

### 4.3.2 Queues Setup

Each newly accepted QoS request requires setting up appropriate queues in the data plane. These configurations are carried out by the OVSDB agent that translates queue setup commands into OVSDB protocol messages. HTB queueing discipline needs to be configured with root class in advance. This step is performed as soon as the switch connects to the controller. Each class is configured with a priority, minimum rate, and maximum rate. The OVSDB module sends a `transact` RPC method to each switch in the selected path. The `transact` method contains a series of operations to set up the new queue configuration in switch database.

### 4.3.3 Installing OpenFlow Rules

After queues are configured using OVSDB agent, the QoS provisioning module will install OpenFlow rules at each switch along the path (or paths) for all traffic flows that belong to this class. The installed OpenFlow rules match each traffic flow and direct its packets to the queue ID configured for the class. This module consumes the controller northbound APIs.

### 4.3.4 Monitoring and Reporting

Monitoring is an important task that complements the installation and configuration of QoS. The module retrieves statistics from data plane switches periodically. It presents them to system administrators and authorized applications using REST APIs. Each report of queue statistics include:

- The number of transmitted bytes.
- The number of transmitted packets.
- The number of dropped packets.

## 4.4 Provisioning QoS to Latency-Sensitive Flows

The HTB qdisc allows arranging traffic classes in a multi-layered hierarchical tree. In our system, we use two layers where the root node (in the first layer) represents the parent class for all kinds of traffic. The root node is configured as soon as a switch connects to the controller. The maximum rate and minimum rate for the root class are both equal to the link speed. For each accepted QoS request, the admission control creates a leaf node linked to the root node with the properties specified in the request. The two main properties are the minimum rate and priority. Typically, the maximum rate for the class is equal to the root (link speed) unless explicitly stated otherwise in the request.

The minimum rate is the guaranteed bandwidth given to the class. However, it is possible for a class to exceed this limit up to its maximum rate (or *ceil*). This happens when it is possible for the leaf node to *borrow* tokens (i.e., consume unused bandwidth) from its parent class. At any point in time, the leaf node can have one of three states:

- **Throughput reached max-rate.** It cannot send packets nor borrow tokens from its parent. Packets of the class will remain in the queue until tokens become available.
- **Throughput reached min-rate.** It can try to borrow tokens from its parent. If tokens are available then packets will be transmitted in a number matching the available tokens. Otherwise, packets will remain in the queue until tokens become available.
- **Throughput is less than min-rate.** It can send packets as long as there are enough tokens.

Tokens are added to the class bucket in the specified minimum rate until the bucket size is reached. Packets belonging to a class are sent only if its corresponding bucket have available tokens. Otherwise, packets will have to wait in the class queue until new tokens become available. By default, FIFO queue is attached to each leaf class. Arriving packets are dropped if their class queue is full. Increasing the size of the queue buffer reduces the packet loss ratio. However, large buffer size can lead to an increased latency for lower priority traffic.

For each packet sent, a token is withdrawn from its bucket (for simplicity, we assume one token represents one packet). If the class bucket is empty and the class queue has packets, it tries to borrow tokens from the parent class. When multiple classes try to borrow from the same parent, the classes with highest priority are served first. If two or more classes have the same priority, the spare bandwidth is



split between them. Priority is represented as a number between 0 and 7 where 0 is the highest priority. The leaf class is allowed to borrow and consume tokens until its maximum rate is reached.

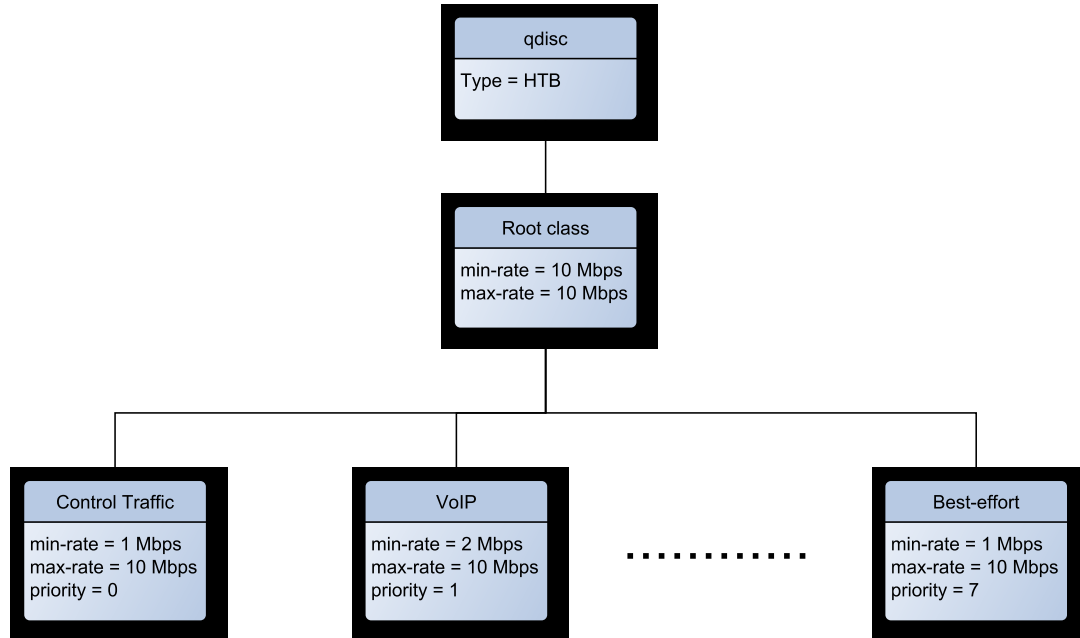

Figure 4.3: Example of different traffic classes

While OpenFlow protocol can be used to install rules that utilize existing queues, it cannot be used for creating new queues. Switch configurations, which includes queues among other attributes, are defined outside the scope of OpenFlow. Using command-line-interface (CLI) of the switch is not a convenient method, specially for dynamic configuration of a large number of switches. There are two protocols proposed for switch configuration. The OpenFlow Management and Configuration Protocol (OF-CONFIG) [38] and the Open vSwitch Database Management Protocol (OVSDB) [39]. We chose to implement OVSDB protocol because it is fully supported by OpenvSwitch.

OVSDB itself is based on JSON-RPC protocol version 1.0 [40]. Switch configuration are stored in a database with defined schema [41]. Manipulating this database, using OVSDB, allows applications to dynamically manage the switch and

modify its configuration.

The OVSDB module establishes a communication channel with each switch connected to the SDN controller. Initially, it retrieves database schema and switch configurations. Then it makes sure each switch port is configured to have an HTB qdisc root class. After that, it makes it available for other modules to retrieve and modify the configurations, including creating new queues. The admission control module consumes this functionality initially to check if there is available capacity for new request and then subsequently to create new classes for accepted requests.

#### 4.5 Performance Evaluation

To evaluate our SDN-based system, we conducted experiments using the Global Environment for Network Innovations (GENI) testbed environment [42]. GENI provides an infrastructure that allows researchers to execute experiments in the field of networking and distributed systems. In our experiments, the topology is linear consisting of three switch nodes. We used the software switch OpenvSwitch [22]. The bandwidth is 10Mbps for all links. The topology is shown in Figure 4.4. To simulate high priority control traffic, we developed a tool that exchange messages over TCP protocol and measure network performance. We executed the same experiment twice over a period of 30 seconds, one with our QoS system and the other one without the QoS system. The high priority control traffic was from VM1 to VM3. In the same time, low priority background traffic was generated between VM2 and VM4. We used *iperf* to generate UDP traffic. UDP is suitable for simulating background traffic because it does not have congestion control that reduces the sending rate when a network congestion occurs.

Results from running both experiments show a huge difference in the measured latency of control traffic. Without the QoS system, the latency ranged from 41 ms to 207 ms (see Figure 4.5). However, with our QoS system, the latency ranged from

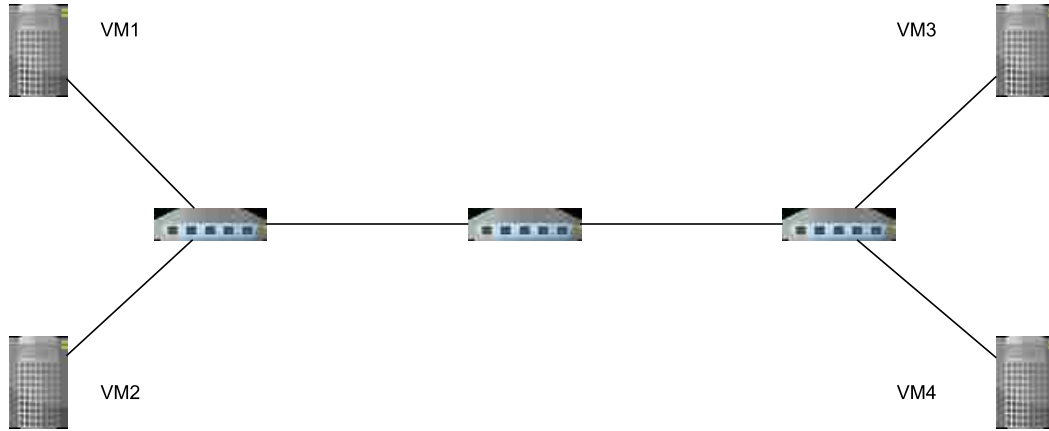

Figure 4.4: Experiment topology

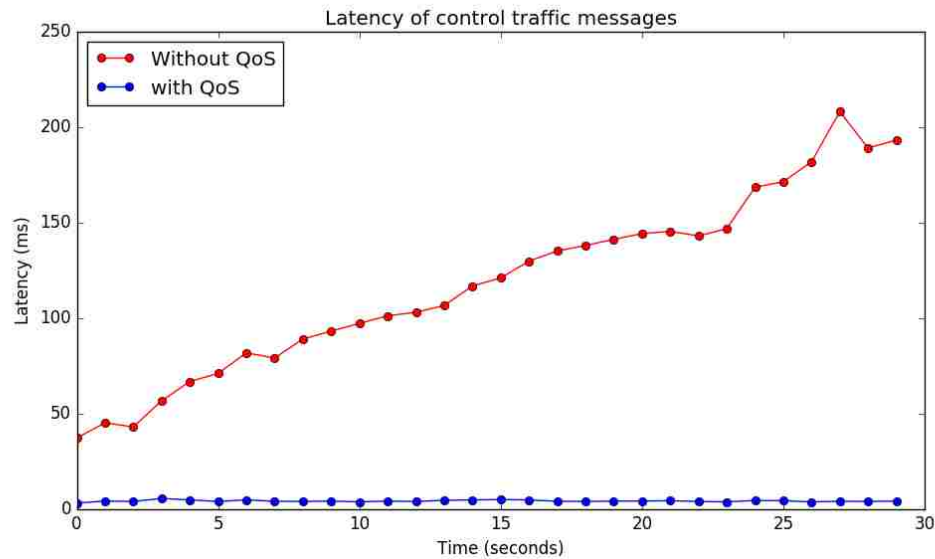

Figure 4.5: Measured latency of control traffic messages

3.9 ms to 5.1 ms.

The same experiment was repeated with TCP background traffic. Results show that there was no significant impact on the latency of control traffic even without running QoS module. The reason is because the congestion control algorithm for TCP reduces the sending rate when it detects a congestion in the network maintaining what is called TCP friendliness. Additionally, we were sending a single TCP flow on

the same path. This result shows the huge difference between the two transport protocols.

#### **4.6 Summary**

In this chapter, we proposed a system to address the challenge of providing QoS to latency-sensitive traffic. Queueing delay constitutes a significant part of the total delay of transmitted packets. Using SDN, the proposed system dynamically allocates queues for different classes of traffic. It accommodates classes of different priorities and attributes. Evaluation results show that latency of high priority traffic is minimized even with the existence of UDP background traffic that saturates the network path.

# Chapter 5

## Improving Throughput of Large Flows Using Multipath TCP

### 5.1 Overview

The recent developments in data center topologies offer high bandwidth capacity and multiple paths between processing nodes. The increased use of cloud computing applications imposes challenges on underlying network infrastructure. To meet these challenges we need efficient traffic management that can maximize the utilization of multi-path data center networks. Path diversity not only provides the opportunity of performing load balancing and improves fault tolerance, but also can be exploited to allocate more bandwidth for large flows and improve the performance of network-limited applications.

In this chapter, we present an architecture based on Multipath TCP and Software Defined Networking to provide better bandwidth allocation for large flows. The SDN controller, which has global knowledge of network topology and traffic measurements, is capable of making educated routing decisions. The proposed SDN architecture enables applications to achieve better throughput for large flows by initiating new MPTCP subflows. To provide this capability, we modify the MPTCP implementation

in the Linux kernel to enable applications to create additional MPTCP subflows on demand. These MPTCP subflows are placed on least-congested paths by the centralized controller. The evaluation results obtained from running experiments on the GENI testbed environment show a significant improvement in the throughput of large flows.

### 5.1.1 Motivation

Data centers evolved in recent years to provide high bandwidth capacity and multiple paths between processing nodes. This was driven by increased deployment of various applications like big data processing and cloud computing. To maximize the utilization of multiple paths there is a need for efficient routing techniques. The hash-based Equal Cost Multi-Path (ECMP) can be used for multi-path routing to distribute traffic flows among equal paths. However, ECMP cannot fully utilize the available capacity of multiple paths. This is mainly due to hash collision of large flows which can lead to bottlenecks in the network while other paths are under-utilized. Figure 5.1 illustrates two examples where ECMP hash collisions affect the throughput of long-running flows [43]. Two flows shared the same link because of hash collision at the aggregate layer and the other two flows collided at the core layer. This path assignment reduces the throughput of all four flows by 50%.

MPTCP can alleviate this problem by creating multiple subflows that can go through different paths. The congestion control of MPTCP adapts to detected congested paths and increases traffic of other subflows. It does this while maintaining TCP friendliness making sure that MPTCP and regular TCP can coexist in the same environment [44]. However, using ECMP with MPTCP does not guarantee that subflows of the same connection will go through different paths. Therefore, relying on ECMP to forward traffic flows can limit the potential

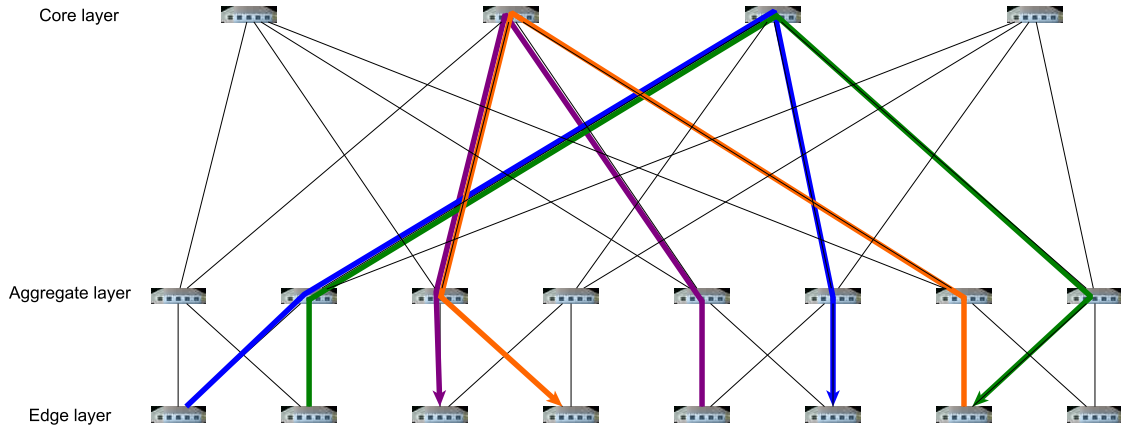

Figure 5.1: Two examples of ECMP hash collision

throughput gain of using MPTCP.

While it is beneficial to use MPTCP for large flows, it can have adverse impact on short flows. Each new MPTCP subflow entails additional overhead and consumes host resources. Moreover, maintaining multiple MPTCP subflows each going through a different path can result in increased latency. Short flows are typically sensitive to latency. Therefore, MPTCP should be used only for large flows.

We propose an architecture based on SDN to improve throughput of large flows in data centers. In this architecture, applications create new MPTCP subflows for long running connections. These newly created *auxiliary* subflows are routed by a centralized flow scheduler in the SDN controller. It should be noted that the first subflow of each long-running connection and short flows are not forwarded to the controller. Thus, there is no scheduling delay for short flows. Also the connection of a large flow will be not interrupted as the first subflow will be routed using load balancing OpenFlow rules proactively installed by the SDN controller. The first subflow will remain on the same path until the data transfer is finished.

### 5.1.2 Data Center Topologies

The design of data center networks focused recently on using cheaper commodity hardware rather than expensive high-end routers and switches. The motivation of this trend is to build more cost-efficient networks that meet current computing requirements. Several designs address issues like bottlenecks and limited bisection bandwidth of traditional data center networks by inter-connecting multiple commodity switches.

The  $k$ -ary Fat Tree topology [45] is a Clos [46] topology that arranges  $k$ -port switches in a multi-rooted tree structure. The core layer has  $(k/2)^2$  switches connected to  $k$  pods. Each pod contains  $k/2$  aggregation layer switches and  $k/2$  edge layer switches. The topology supports  $(k^3)/4$  hosts. Figure 5.9 shows this topology where  $k = 6$ . Other designs include BCube [47], Jellyfish [48], and VL2 [49].

These topologies bring new traffic engineering challenges to data centers. SDN architecture can play a significant role in solving these challenges. Controller applications are capable of monitoring the changing traffic conditions and pushing OpenFlow rules to adapt to the current traffic requirements.

## 5.2 Multipath TCP

Multipath TCP is an extension to regular TCP protocol that provides the ability for a single TCP connection to operate on multiple paths [50]. This extension does not require any modification to the application layer as the transport layer transparently handles the multiple connections, called *subflows*, which appear as a single connection to the application. It is also transparent to the network layer as each subflow appears as a normal TCP connection. Figure 5.2 depicts MPTCP and TCP in the protocol stack. Each MPTCP subflow can go through a different path in the network, or even a different network interface if the host has multiple network interfaces (multi-homed host). The MPTCP extension provides more resilience to TCP protocol as



the connection will not be interrupted if one link goes down as long as there exists at least one connected subflow. Another benefit is providing applications with more bandwidth by aggregating multiple paths.

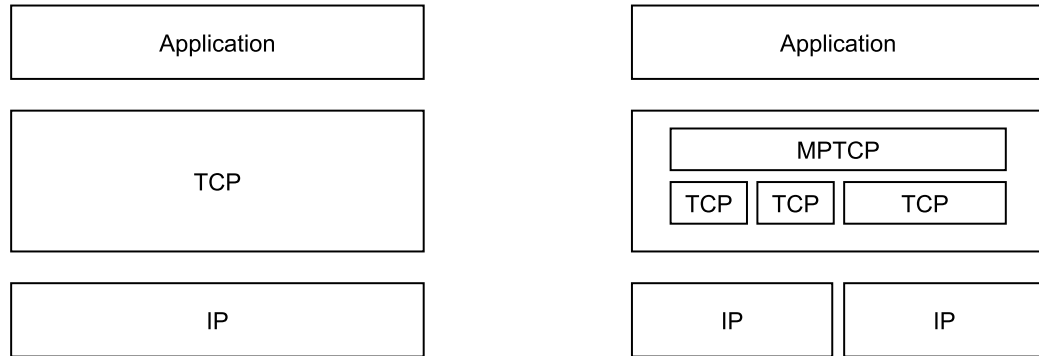

Figure 5.2: TCP and MPTCP protocol

One of the key design features of MPTCP is the fallback to regular TCP if MPTCP is not supported by either host or any middlebox. A new TCP option kind is introduced to indicate that the TCP connection supports MPTCP. This option kind has the decimal value *30*. The TCP option also contains MPTCP subtype which is used to signal MPTCP operations (e.g., MP\_JOIN is used by new subflows to request joining an existing MPTCP connection). Table 5.1 lists MPTCP option subtypes [50].

Table 5.1: Multipath TCP Option subtypes

Symbol	Value	Name
MP_CAPABLE	0x0	Multipath capable
MP_JOIN	0x1	Join connection
DSS	0x2	Data sequence signal
ADD_ADDR	0x3	Add address
REMOVE_ADDR	0x4	Remove address
MP_PRIO	0x5	Change subflow priority
MP_FAIL	0x6	Fallback
MP_FASTCLOSE	0x7	Fast close

A Multipath TCP session starts in the similar way to a regular TCP session. The difference is that SYN, SYN/ACK, and ACK packets carry the MPTCP option kind (30) with MP\_CAPABLE option subtype. MP\_CAPABLE option subtype is used by the first subflow of MPTCP connection to indicate that the sending host supports MPTCP. If the sending host receives a SYN/ACK without MP\_CAPABLE it assumes that the other host does not support MPTCP. The other possibility, although highly unlikely, is when a legacy middlebox modify TCP options because it was configured to remove unrecognized TCP options. In this case, the connection falls back to regular TCP and the two hosts continue to exchange packets through a single TCP flow. If both hosts completed the three-way handshake with MP\_CAPABLE, then they have established a Multipath TCP connection and either one can initiate additional subflows. During the initial three-way handshake, the two hosts exchange keys used to associate subsequent subflows with this connection. The keys are unique for each connection. Figure 5.3 illustrates the process of establishing a Multipath TCP connection using MP\_CAPABLE and then adding one additional subflow using MP\_JOIN.

The keys exchanged in MP\_CAPABLE handshake are used to generate cryptographic hashes called *tokens*. After that, the keys are not sent over the network. Instead, the cryptographic hash of the key, or token, is used to identify the connection. Tokens are used in MP\_JOIN to associate the subflow with existing MPTCP connection. The purpose of using tokens is to make sure that the new subflow will join the correct MPTCP connection. The Hash-based Message Authentication Code (HMAC) generated from the key and nonce (random number) is used for authenticating the other host.

New MPTCP subflows do not need to be between different IP pairs. It is possible to have multiple subflows from the same IP pair given that they operate on different TCP ports. Typically, this is beneficial where ECMP is used to forward traffic flows,

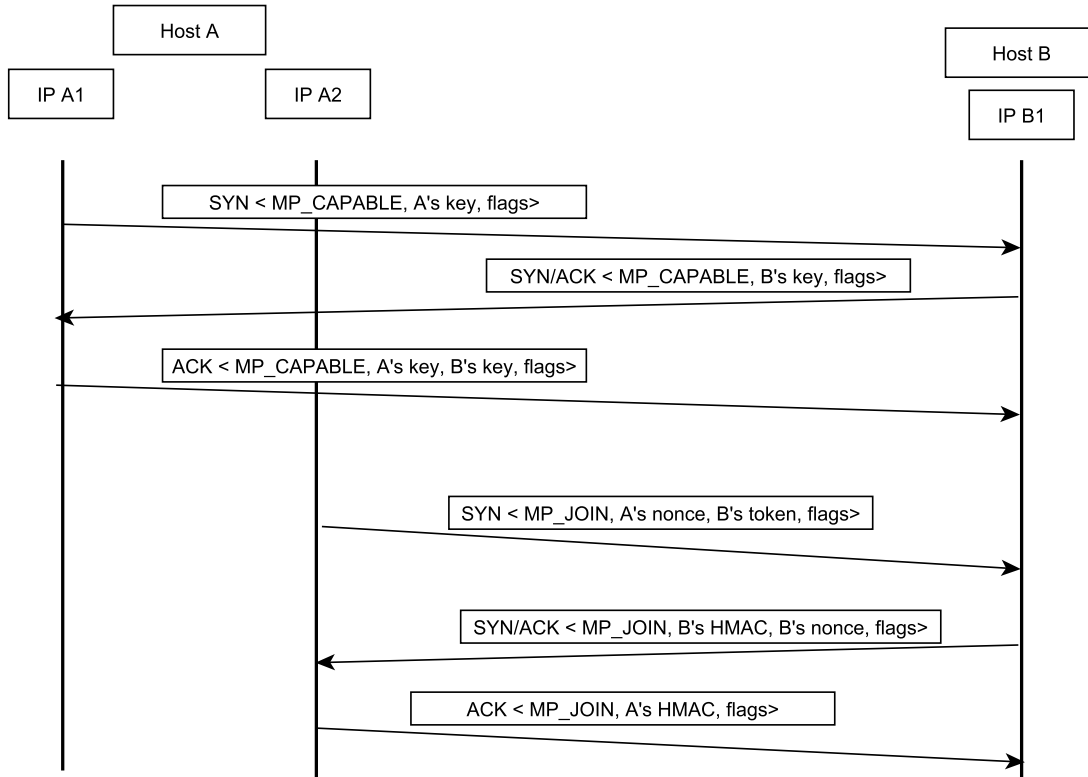

Figure 5.3: MPTCP subflows initiation

as these subflows can have different paths which will lead to increased throughput for the application. However, as we discussed earlier, ECMP employs hashing and there is no guarantee that multiple subflows of the same connection will end up in disjoint paths.

### 5.2.1 Congestion Control

In regular TCP, the congestion control plays a pivotal role in avoiding congestion collapse in network. TCP maintains what is called *congestion window* to keep the transmission rate below the level that can cause network congestion. It basically limits the number of unacknowledged data at the source host. The size of the congestion window is changed throughout the connection lifetime to adapt to detected congestion signals. The destination host normally sends an acknowledgement (ACK) to the

source host for each received packet. The source host infers that a packet loss has occurred when it does not receive an ACK before a timeout. TCP calculates this timeout, called retransmission timeout (RTO), based on smoothed value of estimated round-trip time (RTT) between source and destination hosts [51]. In addition to RTO, the duplicate acknowledgements (DupACK) are considered a congestion signal. When the host receives an out of order packet it sends an ACK for the last in-order packet it had received so far. Sending a DupACK means that the receiver is still expecting the next packet. However, since a packet can get delayed or reordered while in transit, three DupACKs are needed to detect a packet loss.

TCP adjustments for the congestion window follow the approach of additive increase/multiplicative decrease (AIMD). That means TCP will increase the transmission rate by adding a value to the congestion window when it receives a new ACK, and will decrease the transmission rate by a multiplicative factor (e.g., divide by 2) when a packet loss is detected. This conservative behavior is essential in avoiding network congestion. We will leave out the discussion of different TCP implementations (e.g., Tahoe , Reno, New Reno, etc.) and the other TCP schemes *slow-start*, *fast retransmit*, and *fast recovery* as they are beyond the scope of this research.

In MPTCP, the role of congestion control expands to include issues that do not exist in single path TCP. The main issues are fairness to regular TCP and shifting traffic from congested paths to other paths that have less traffic. To explain the issue of fairness, consider that each MPTCP subflow behave like regular TCP. If a single TCP connection shares a bottleneck with only one MPTCP connection that has two subflows, this will result in the TCP flow getting half the throughput of MPTCP connection. This mechanism is known as *uncoupled* congestion control. In this mechanism, each MPTCP subflow  $s$  maintains its own congestion windows  $W_s$  and the AIMD behavior is as follows:

- Each ACK on subflow  $s$  will increase the window  $W_s$  by  $1/W_s$ .
- Each detected loss of subflow  $s$  will decrease  $W_s$  by  $W_s/2$ .

The aggregated throughput of the MPTCP connection is excessively large. However, this gain can be on the expense of competing TCP flows on shared bottlenecks. This behavior is too aggressive against single flow TCP and violates the design principle “do no harm”. In order for a new protocol to be adopted, it has to be fair to existing protocols. Therefore, MPTCP subflows should not behave like regular TCP flows.

The *coupled* congestion control tries to solve this problem by changing AIMD parameters. In the coupled congestion control, each MPTCP connection maintains a congestion window  $W_{total}$  which is equal to the sum of all  $W_s$  maintained by its subflows. The  $W_s$  is bound to be  $\geq 1$ . The AIMD behavior is as follows:

- Each ACK on subflow  $s$  will increase the window  $W_s$  by  $1/W_{total}$ .
- Each detected loss of subflow  $s$  will decrease  $W_s$  by  $W_{total}/2$ .

The coupled congestion control achieves the goal of fairness to regular TCP by taking into account the total congestion window of all subflows. In addition to that, it balances traffic between subflows based on encountered congestion signals. By shifting traffic from subflows on congested links to other subflows on least-congested paths, the throughput of other flows on congested bottlenecks will increase. Consequently, the overall network will achieve better resource utilization and load balancing. However, coupled congestion control have drawbacks that have been discussed in [44]. First, it favors the paths with less packet loss ratio regardless of their RTT values. Some routers are configured with large buffers to reduce packet drops which in the same time can lead to increasing RTT. However, smaller RTT value will result in higher throughput. The second issue is that because traffic can be shifted entirely from

congested paths, there is no way to indicate that such paths are available when they become less congested. It becomes clear that there need to be sufficient traffic on each subflow to probe the paths regardless of how congested they are.

The linked increases algorithm (LIA) [52] was proposed to address the drawbacks of coupled congestion control. LIA aims to achieve the following goals:

1. Improving throughput: MPTCP connection should achieve throughput equal to or greater than what a single TCP flow would have achieved on the best path available to MPTCP.
2. Not harming: MPTCP subflows of the same connection sharing a network resource should not take more capacity than a single flow would have on the same path.
3. Balancing congestion: MPTCP connection should shift traffic from most-congested paths to least-congested paths as much as possible.

The AIMD behavior in LIA is as follows:

- Each ACK on subflow  $s$  will increase the window  $W_s$  by:

$$\min\left(\frac{\alpha * bytes\_acked * MSS_s}{W_{total}}, \frac{bytes\_acked * MSS_s}{W_s}\right)$$

The minimum increment value is 1.  $MSS_s$  is the maximum segment size for subflow  $s$ .

- Each detected loss of subflow  $s$  will decrease  $W_s$  by  $W_s/2$ .

$\alpha$  is a parameter that controls the aggressiveness of MPTCP. It is calculated based on the estimated RTT as follows:

$$\alpha = W_{total} \frac{\max_s\left(\frac{W_s}{(RTT_s)^2}\right)}{\left(\sum_s\left(\frac{W_s}{RTT_s}\right)\right)^2}$$

The combined throughput for an MPTCP connection in LIA depends on the values of  $\alpha$ , the packet loss ratio, RTT and MSS for each of its subflows. LIA is part of Linux kernel implementation of MPTCP. We used this congestion control in our demonstration because it provides better throughput gain while not harming regular TCP flows. Additionally, shifting traffic between subflows depending on congestion signals is important to achieve adaptive load balancing.

### 5.3 Related Work

There has been a significant number of research efforts for improving the performance of data center networks. The issue of routing large flows was of particular interest to many proposals. Hedera [43] detects large flows from continuous monitoring of network measurements by the SDN controller. Traffic flows are initially forwarded using a hash-based routing method similar to ECMP. If a flow exceeds a certain rate threshold (a percentage of the host's link capacity), it is considered a large flow and the centralized controller starts the process of scheduling it. It begins with estimating the natural demands for all active large flows in the data center. Then it runs a centralized flow scheduler to re-assign large flows to paths that suffice the natural demand. Two algorithms were proposed for scheduling large flows: Global-First-Fit and Simulated-Annealing [43].

Mahout [53] is another effort that proposes a different approach for detecting large flows. They argue that Hedera's method of detecting large flows by monitoring switches' statistics results in late detection and poses a huge burden on the controller which can limit its scalability. Instead, they propose detecting large flows at the end hosts. To achieve this purpose, they developed a shim layer between TCP/IP stack and device driver (implemented as a Linux kernel module) to monitor the socket buffers. When the socket buffer exceeds a specific threshold, the flow is considered a

large flow. This approach distinguishes between network-limited flows (the network is the bottleneck) and application-limited flows (the application sending rate is lower than what the network is able to accommodate). The application-limited long running flows will not be determined as large flows regardless of how much data they have transmitted as long as their socket buffers are below the threshold. However, if the application is filling the socket buffer in a rate that exceeds what the network can transmit, then the flow is determined as a network-limited large flow that requires special management from the SDN controller. The shim layer detects such flows and mark their DSCP field so that it can be forwarded to the SDN controller by switches. The controller reroutes large flows through the least-congested paths. Monitoring the TCP send buffer was also studied in [54]. Instead of classifying flows and marking their packets, they propose advertising the occupancy of TCP send buffer by encoding them in each outgoing packet.

The aforementioned efforts did not consider using MPTCP or multipathing in general. The benefits of using MPTCP in data centers were studied in [55]. They highlighted that using MPTCP in multi-path data center networks improve the throughput and achieve better fairness on many topologies. Their experiments led them to propose a dual-home variant of Fat Tree topology. Using this topology along with MPTCP resulted in performance enhancements for a wide range of workloads. However, they relied on ECMP for routing MPTCP subflows. They did not discuss the use of a centralized flow scheduler or SDN.

The integrated use of SDN and MPTCP was proposed in [56]. The aim of their proposal is to improve the throughput in shared bottlenecks. Multiple subflows of the same MPTCP connection are forwarded by the SDN controller. Their mechanism involves using disjoint paths to route MPTCP subflows instead of using ECMP. However, disjoint paths are not necessarily the optimal paths as we will show in this chapter. Additionally, they did not consider differentiated treatment of



short flows and large flows. All MPTCP subflows need to be forwarded to the SDN controller for processing. This reactive approach places a significant burden on the controller.

Researchers in [57] proposed an MPTCP-aware SDN controller design for data center networks. The SDN controller uses packet inspection to extract MPTCP options and use this information to assign different paths to subflows. They evaluated the routing based on shortest paths and disjoint paths. Their evaluation results demonstrate better performance compared to ECMP. However, they did not consider forwarding based on network traffic measurements. Moreover, they did not differentiate between short flows and long flows. Similar to [56], all flows are processed reactively by the SDN controller.

MMPTCP [58] is another proposal to utilize MPTCP in data centers that differentiates between short and long flows. They set threshold for transmitted data to distinguish between short and long flows. Short flows are transmitted using Packet Scatter (PS). Packet scatter forces ECMP to route each packet of the same flow as if they are different (using source port randomization which leads to different 5-tuple hash). After transmitted data exceed switching threshold, MMPTCP creates new subflows of the same connection and stops sending data in the first subflow. The remaining of the connection is handled as regular MPTCP. Packet scatter can cause packet reordering problems. They did not consider using SDN architecture.

#### **5.4 SDN Based Architecture for Improving Throughput of Large Flows**

The proposed architecture aims to improve throughput of large flows while not affecting short flows in data center networks. It combines SDN architecture and MPTCP protocol. Transport protocols like MPTCP have no knowledge of network topology and cannot dictate how packets are routed in the network. SDN controller

have global knowledge of network topology and is able to get updated traffic statistics of each switch port. The controller application starts with setting up OpenFlow rules to route short flows without being forwarded to the controller. Then it installs rules to redirect auxiliary subflows to the controller which will be handled by the path searching module.

Auxiliary subflows of the same connection are not necessarily placed on disjoint paths. The SDN controller application performs a search based on the current available capacity of each link. This adaptive search increases the potential throughput gain of each additional subflow. To illustrate the difference between disjoint path search and adaptive path search, consider the simplified example shown in Figure 5.4. The links show the available bandwidth capacity in the current network conditions. If we have two subflows and assign them to the shortest disjoint paths, their aggregate capacity would be 4 Mbps. However, the aggregate capacity is increased to 9 Mbps when using our adaptive SDN forwarding.

The first step in this process is to differentiate between short flows and long flows. Once a flow is determined to be a long flow, it will be split into multiple subflows to gain more throughput. For the purpose of demonstration, we decided not to set hard thresholds and delegate this task to the application layer to have more flexibility in experimenting with different levels of thresholds. Large flows will be running on multiple auxiliary subflows in addition to the first subflow. The auxiliary subflows will have marked DSCP field which will trigger switches to forward them to the controller. The main components of this architecture are:

- OpenFlow based load balancing for short flows using group tables.
- Adaptive flow scheduler for routing auxiliary subflows of large flows.
- Extended socket API for the Linux kernel implementation of MPTCP.

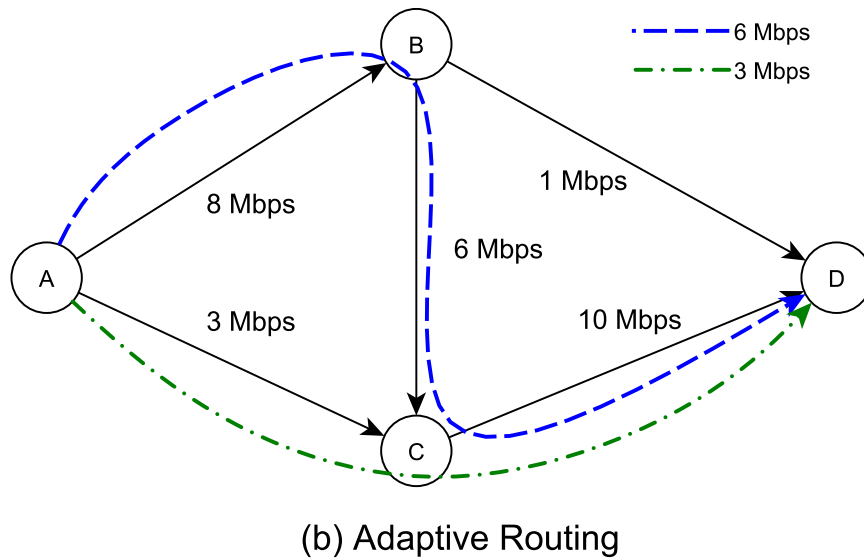
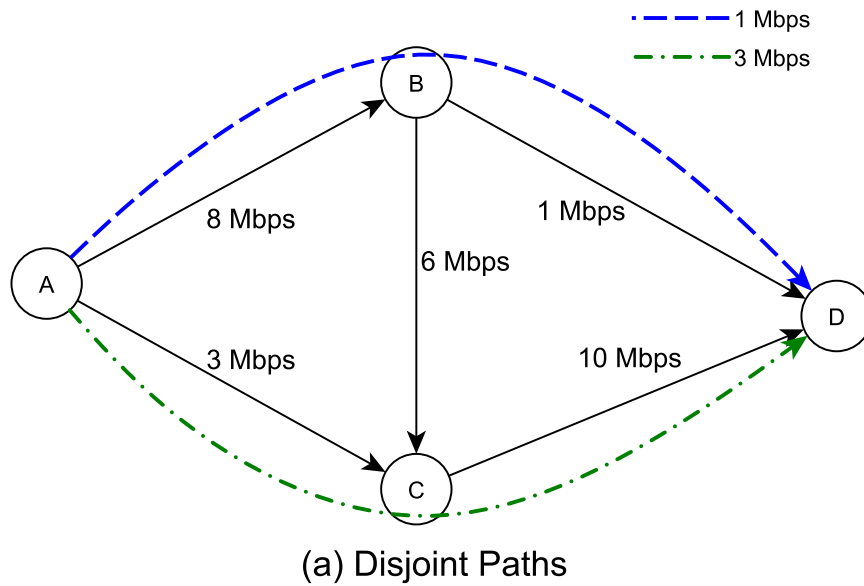

Figure 5.4: Disjoint paths vs adaptive routing

#### 5.4.1 Load Balancing with OpenFlow Group Tables

The first part of our proposed architecture deals with routing short flows and the first subflows of large flows. Short flows are usually sensitive to latency and come in large numbers. Having short flows forwarded to the SDN controller to process

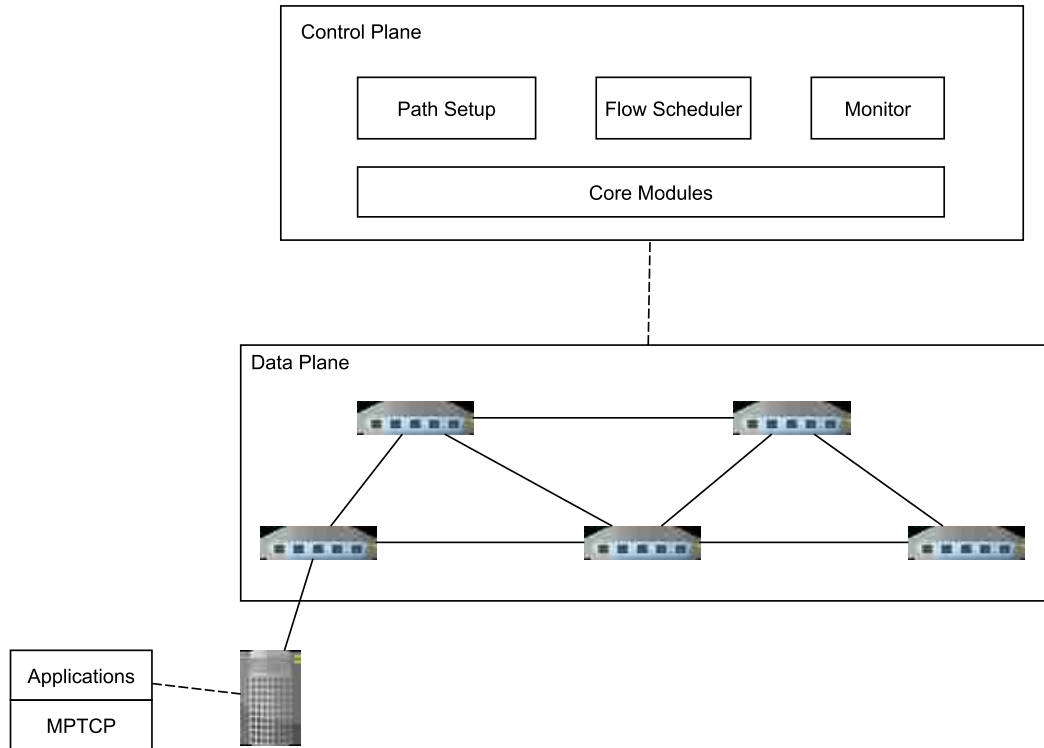

Figure 5.5: SDN-based architecture for improving throughput of large flows

them reactively is not practical. It is not a scalable solution because it increases the number of OpenFlow rules and put a significant burden on the controller. In addition to that, processing delay at the control plane increases the latency. Therefore, it is better to handle them in the data plane only. The controller can install forwarding rules proactively to forward traffic. For the purpose of performing load balancing, we need to an efficient method to split traffic flows that are not routed reactively by the controller.

*Group* tables were introduced in OpenFlow version 1.1 [27]. They provide an abstraction for representing a set of ports as a single entity. Each OpenFlow group table contains a set of *action buckets*. These buckets specify the actions that are going to be applied to packets from matching flows. There are different types of groups that can be used for various purposes. Group types include:

1. Indirect: contains only one bucket. Typically useful in the case where multiple flow entries need to point to a single common set of actions.
2. All: contains multiple buckets. All buckets are executed for each matching flow packet. This is useful for applications like multicasting or broadcasting.
3. Select: Contains multiple buckets. Only one bucket is executed for each matching matching flow (see Figure 5.6).
4. Fast failover: Contains ordered list of buckets. Each bucket is associated with a port/group to monitor its status. It executes first bucket whose status is live.

We use OpenFlow group tables to distribute flows between different paths. Traffic flows that match installed OpenFlow rules will be redirected to group tables. Each bucket has an associated weight which specifies the probability of selecting the bucket for each matching flow. The bucket selection algorithm is not defined in OpenFlow specifications [27] and left to switch implementation. Possible implementations include weighted round-robin and hashing algorithms. OpenvSwitch [22], which is used in our evaluation, implements hashing to select the bucket.

In our design, the controller installs OpenFlow group tables in each switch and the corresponding matching rules to distribute traffic flows equally among multiple paths. The matching rules are installed with the lowest priority. While it is possible that hashing can lead to uneven distribution in the beginning, it converges to even distribution as the number of flows increases.

#### 5.4.2 Routing Auxiliary Subflows

The auxiliary subflows are distinguished from other traffic flows by their Differentiated Services (DS) field. The DS field contains a 6-bit Differentiated Services Codepoint (DSCP) field and a 2-bit Explicit Congestion Notification (ECN) field. The DSCP

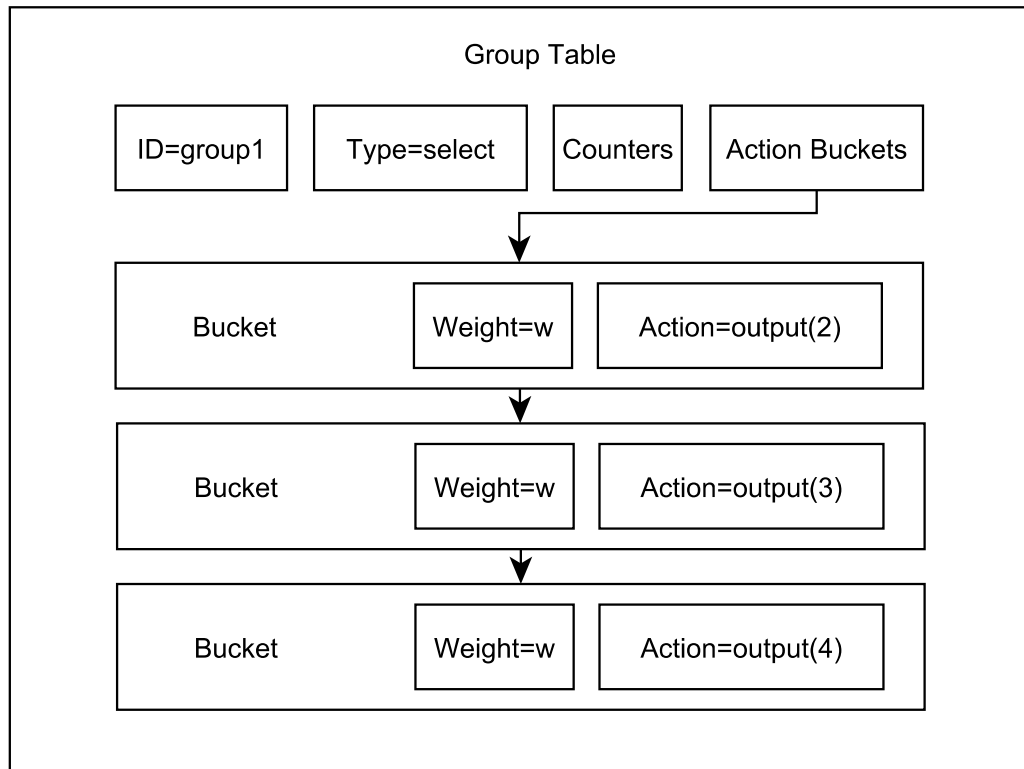

Figure 5.6: OpenFlow group table

is used originally in Differentiated Services (DiffServ) to classify traffic into different classes based on their Quality of Service (QoS) requirements. We utilize a pool of codepoints that are reserved for experimental or local use [59]. This pool has 16 distinct values within the codepoint space *xxxx11*.

The controller installs OpenFlow rules in the data plane to forward traffic flows with marked DSCP (auxiliary subflows) to the control plane for processing. These rules have higher priority than group table rules that handle the forwarding of short flows and the first subflows of MPTCP connections. Once a `PACKET_IN` message is received by the controller, it gets processed by our module before any other controller module (e.g., the built-in forwarding module). We perform packet inspection on the encapsulated packet inside `PACKET_IN` message to extract DSCP field and TCP options. If the DSCP value is within our predefined range, we parse TCP options to

check whether it is an MPTCP packet (i.e., it belongs to a new auxiliary subflow) or a regular TCP packet.

TCP segments can have a variable number of optional header fields called TCP options. Their purpose is to provide the ability to create new extensions that are not available in the original TCP headers without requiring changing the existing structure. Each TCP option is identified by a mandatory *option kind*. The length of option kind is always one octet. However, the length of TCP options is variable. These options are maintained by the Internet Assigned Numbers Authority (IANA) [60]. Two TCP options have no additional information other than their option kind. The `END_OF_LIST` option (0x00) which indicates the end of options list, and the `NO_OPERATION` option (0x01) which is used for padding. All other options have two other fields: *option length* and *option data*. The option length specifies the length of all three fields (not only the option data). The option kind of MPTCP option is 30 (0x1e). In the initial SYN MP\_JOIN packet, the length of MPTCP option is 12. To extract MPTCP token we need parse TCP options (see algorithm 2). The first four bits of option data contains MPTCP subType (the list of subTypes are shown in table 5.1) followed by four bits of flags and one octet for address ID. The next four octets are the receiver's token. Figure 5.7 shows the structure of MPTCP option for MP\_JOIN SYN packet.

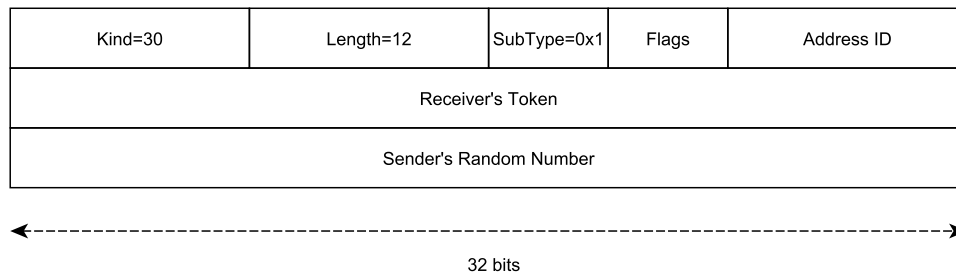

Figure 5.7: MPTCP option for MP\_JOIN SYN packet

---

**Algorithm 2** extractMPTCPToken(packet)

---

```
tcpOptions ← getTCPOptions(packet)
i=0
while i < tcpOptions.length do
  opKind = tcpOptions[i]
  switch opKind do
    case 0x00:                                ▷ End_Of_List
      return null
    case 0x01:                                ▷ No_Operation
      i += 1
      continue
    default:
      i += 1
      opLen ← tcpOptions[i]
      if opKind==0x1e then                    ▷ MPTCP option
        i += 1
        subType ← tcpOptions[i] & 0xF0        ▷ subType is only 4 bits
        if subType==0x10 and opLen==12 then  ▷ MP_JOIN in SYN
          token ← Copy(tcpOptions, i+2, i+6)
          return token
        else                                  ▷ not MP_JOIN
          return null
        end if
      else                                    ▷ other TCP option
        i += (opLen -1)
      end if
  end while
return null
```

---

For each new auxiliary subflow, our module executes a search algorithm to find a list of best paths for this connection (see algorithm 3). In the beginning, it extracts the MPTCP receiver token associated with this auxiliary subflow. MPTCP connections are identified by their unique receiver tokens. If it matches a cached flow then its path is retrieved and installed. Otherwise, it means the auxiliary subflow belongs to a new MPTCP connection. The best path in our case is the widest path obtained by a modified version of Dijkstra algorithm (see algorithm 4). The search is based on the current topology and updated traffic measurements. The controller periodically collects traffic statistics from each switch.



If the incoming PACKET\_IN message is for the first auxiliary subflow of an MPTCP connection, the list of paths are cached for subsequent auxiliary subflows of this connection. So the search algorithm needs to be executed only once for each connection regardless of the number of its auxiliary subflows. The installed OpenFlow rules have soft timeout and will be deleted after they become inactive. The switches notify the controller of expired OpenFlow rules by sending FLOW\_REMOVED message which will allow the controller to clear the corresponding entry in the cached flows. Using this method does not interrupt traffic that goes through the first subflow, which is routed using OpenFlow group table rules without going to the controller. It only enables large flows to gain more throughput and finish faster by utilizing multiple subflows, path diversity and SDN. The congestion control for MPTCP adapts to changing traffic conditions and shifts traffic from congested links to other subflows without harming existing TCP connections.

---

**Algorithm 3** getPath(packet)

---

```

token ← extractMPTCPToken(packet)
if exists(cachedPaths[token]) then
    p ← dequeue(cachedPaths[token])
    install(p)
    return
end if
linkCapacity ← topology.getAvailableCapacity()
for i ← 0 to maxPaths-1 do
    p ← dijkstra(flow.src, flow.dst, linkCapacity)
    w ← width(p)
    for l ← p.links do
        linkCapacity[l] ← linkCapacity[l]-w
    end for
    cachedPaths[token].add(p)
end for
p ← dequeue(cachedPaths[token])
install(p)

```

---

---

**Algorithm 4** Dijkstra( $s, v, \text{graph}$ )

---

```
q ← empty
visited ← empty
for node ← graph.nodes do
    width[node] ← 0
    previous[node] ← null
end for
width[s] ← ∞
q.add(s)
while q is not empty do
    node ← q.dequeue()
    if visited.contains(node) then
        continue
    end if
    visited.add(node)
    for link ← graph.connectedTo(node) do
        neighbor ← link.getDestination()
        altWidth ← max(width[neighbor],
            min(width[node], link.getWidth()))
        if altWidth > width[neighbor] then
            width[neighbor] ← altWidth
            previous[neighbor] ← node
            q.add(neighbor)
        end if
    end for
end while
```

---

### 5.4.3 Socket API for Creating Auxiliary Subflows

In order for applications to exploit our SDN architecture, they need the ability to create MPTCP subflows and mark DSCP in the same time. The Linux kernel MPTCP implementation [61] (as of v0.92) does not provide this capability. Researchers in [62] proposed enhanced socket API for MPTCP that extends Linux kernel implementation to provide additional features. The enhanced socket API provides applications with additional features that are not available in the original kernel implementation. The purpose is to allow application developers to have more control on the operation of MPTCP. The list of their API features include retrieving subflow information, creating subflows, terminating subflows, and setting the DSCP field, among other

features.

Despite that the enhanced socket API provides more control over MPTCP operations, they fall short of meeting our requirement. The reason is that setting the DSCP can happen only after the subflow is initiated, which means it is not possible to mark DSCP for SYN packets. In our SDN architecture, SYN packets need to have a specific DSCP value so that it can be forwarded to the controller. The controller needs to extract the MPTCP receiver tokens from SYN packets. The tokens are used as unique keys for identifying MPTCP connections. In the current OpenFlow specifications [27], it is not possible to create OpenFlow match rules against TCP options. Therefore, we rely on the DSCP field to distinguish between auxiliary subflows and other flows. The MPTCP token is sent only with MP\_JOIN SYN packet during TCP three-way handshake. Maintaining MPTCP tokens allows the controller to place auxiliary subflows of the same connection on best paths with highest available capacity. To that end, we have developed new socket API that allows applications to dynamically create DSCP-marked MPTCP subflows for an existing MPTCP connection. The DSCP field is set with flow initiation (i.e., SYN packet).

We describe briefly the enhanced socket API proposed in [62]. New functionalities were implemented above the system calls `getsockopt` and `setsockopt`. They introduced new socket options for querying kernel-level information and performing actions on existing MPTCP connections. The socket options include the following:

- `MPTCP_GET_SUB_IDS`: retrieve the current list of subflows IDs as viewed by the kernel.
- `MPTCP_GET_SUB_TUPLE`: retrieve the IP address and port number of a specific subflow.

- `MPTCP_OPEN_SUB_TUPLE`: request to create a new subflow for an existing MPTCP connection.
- `MPTCP_CLOSE_SUB_ID`: request to close a specific subflow.
- `MPTCP_SUB_GETSOCKOPT`: pass the socket option to `getsockopt` for a specific subflow and return the result.
- `MPTCP_SUB_SETSOCKOPT`: pass the socket option to `setsockopt` for a specific subflow.

Using `MPTCP_SUB_SETSOCKOPT`, it is possible to set DSCP value of a specific subflow. However, as we discussed earlier, this happens only after the subflow has already been initialized and three-way handshake packets exchanged. We introduce new socket option `MPTCP_OPEN_SUB_WITHTOS` that creates a new subflow and marks DSCP in the same time. That is, SYN packets will have the specified DSCP value. The application needs to pass `mptcp_newsub_withtos` struct which is defined as follows:

```
struct mptcp_newsub_withtos {
    char *tosval;           /* DSCP value */
    struct mptcp_sub_tuple *sub; /* sub_tuple of the new subflow*/
}
```

The `tosval` member sets the value of DSCP field. Note that DSCP field is only 6-bit length. Along with the two-bit ECN field, they replace what was previously known as ToS field in the IP packet. The DSCP 6 bits are the most significant bits of `tosval`. For example, the DSCP value (000111) is represented with hexadecimal value (0x1C) because the two least-significant bits are set to zero (00011100). The `sub` member holds the tuple information of the new subflow. Figure 5.8 shows an example of using the new socket option `MPTCP_OPEN_SUB_WITHTOS` to create one additional subflow that has the DSCP decimal value 28 (0x1C). The new subflow uses the same IP pair

and the same destination port of the existing subflow that has the ID `subflow_id`. The subflow ID can be retrieved from the kernel using `MPTCP_GET_SUB_IDS` which provides a list of active subflows with their IDs. The current implementation limits the number of active subflows for a single MPTCP connection to 32 and the subflows are assigned IDs within the range from 0 to 31 [62]. The source port of the new subflow is randomly chosen by the kernel but can be specified if needed. The `mptcp_sub_tuple` information are retrieved using `MPTCP_GET_SUB_TUPLE`.

Our modification to the Linux kernel is very minimal. It introduces new socket API function that allows applications to specify the value of DSCP during subflow initiation. Our work is based on Linux kernel MPTCP implementation v0.92 [61]. It also extends the socket API proposed in [62].

The usage scenario for this extended API is that after a certain threshold of transferred data, the application issues a call to create a new subflow. This should happen only with large flows that take a lot of time to finish transferring data. Specifying the threshold and the number of auxiliary subflows is left to the application.

```

struct mptcp_newsub_withtos *newsub;
struct sockaddr *sin;
struct sockaddr_in *sin4;
unsigned int optlen, newlen;
int DSCPvalue = 28;
newlen = 100;
newsub = malloc(newlen);
if (!newsub) {
    fprintf(stderr, "Error: malloc\n");
    return 0;
}
newsub->tosval= (char *) &DSCPvalue;
optlen = 100;
newsub->sub = malloc(optlen);
if (!newsub->sub) {
    fprintf(stderr, "Error: malloc\n");
    return -1;
}
optlen = 100;
newsub->sub->id = subflow_id; // from MPTCP_GET_SUB_IDS
error = getsockopt(sock, IPPROTO_TCP, MPTCP_GET_SUB_TUPLE, newsub->sub
    , &optlen);
if (error) {
    fprintf(stderr, "MPTCP_GET_SUB_TUPLE error: %d\n", error);
    free(newsub->sub);
    free(newsub);
    return -1;
}
sin = (struct sockaddr*) &newsub->sub->addrs[0];
if(sin->sa_family == AF_INET){
    sin4 = (struct sockaddr_in*) &newsub->sub->addrs[0];
    sin4->sin_port = htons(0); //source port for new flow
    error = getsockopt(sock, IPPROTO_TCP, MPTCP_OPEN_SUB_WITHTOS, newsub
        , &optlen);
    if (error) {
        fprintf(stderr, "MPTCP_OPEN_SUB_WITHTOS error: %d\n", error);
        free(newsub->sub);
        free(newsub);
        return -1;
    }
}
}

```

Figure 5.8: Creating new subflow with with DSCP

## 5.5 Evaluation

### 5.5.1 Experiments Setup

To evaluate our SDN architecture, we conducted experiments using the GENI testbed environment. The network topology used is  $k$ -ary Fat Tree [45]. We deployed a 6-port Fat Tree network that contains 45 switches and 54 hosts. The network topology is shown in Figure 5.9. All host nodes were running Linux Ubuntu with the modified MPTCP kernel. For switch nodes we used the software switch OpenvSwitch [22]. All switch nodes connect to Floodlight controller [24] running our routing and monitoring modules.

For traffic flows, we note that data center traffic patterns vary in size, arrival time, and other properties. Researchers in [63] studied traffic traces in ten data centers and found that approximately 80% of all flows are small in size and finish in less than 11 seconds in most studied data centers. To emulate traffic in data centers we generated two traffic matrices that follow this observation. In traffic matrix TM1, 80% of flows are small and in traffic matrix TM2 70% of flows are small. The traffic pattern is random permutation where each host sends a flow to one random host (in a different rack). The inter-arrival time is randomly chosen between 500 ms and 1000 ms. Each traffic matrix contains 540 flows.

We developed a small application to generate traffic for our experiments. This application can create auxiliary subflows using the new socket API. Auxiliary subflows are initiated after transmitted traffic exceeds thresholds. The purpose of this application is to test the new socket API and SDN controller application. The threshold for creating each additional subflow is 1 MB. Each traffic matrix was executed five times as follows:

1. Regular TCP and ECMP routing.
2. MPTCP with 2 subflows and ECMP routing.

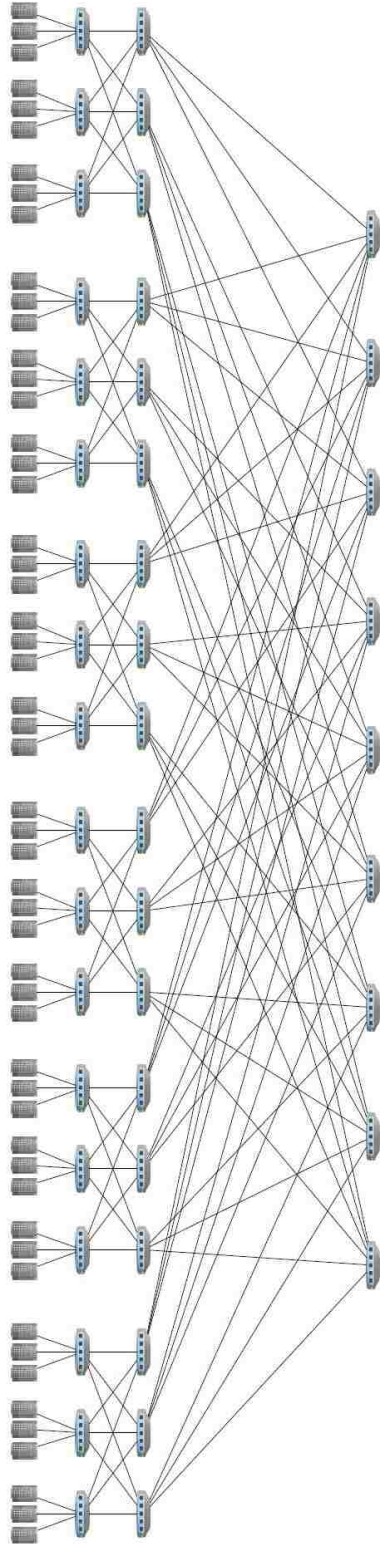

Figure 5.9: Network topology



3. MPTCP with 2 subflows and SDN auxiliary routing.
4. MPTCP with 3 subflows and ECMP routing.
5. MPTCP with 3 subflows and SDN auxiliary routing.

### 5.5.2 Evaluation Results

Results obtained from running these experiments show a significant improvement in throughput of large flows when using MPTCP. This is expected as multiple subflows are able to aggregate bandwidth of different paths. Figure 5.10 shows the average throughput of all large flows in each experiment. In TM1, the average throughput for TCP was 49.4% of the maximum link capacity. Using MPTCP with ECMP increased the throughput to 64.4% with 2 subflows and 72.1% with 3 subflows. Whereas in TM2, TCP average throughput was 36.6%. MPTCP with ECMP improved obtained throughput to 52.4% with 2 subflows and 56% with 3 subflows. However, for all cases of MPTCP, our SDN auxiliary routing performed much better than ECMP. In TM1, the average throughput of MPTCP with SDN routing was 77.8% with 2 subflows and 78.5% with 3 subflows. In TM2, using MPTCP with SDN routing resulted in 63.8% with 2 subflows and 67.4% with 3 subflows. The improvements of using SDN auxiliary routing compared to ECMP ranged from 6.4% to 13.4%.

Figures 5.11 and 5.12 show the CDF of large flows' throughput in TM1 and TM2, respectively. In both traffic matrices, the SDN auxiliary routing with 2 subflows resulted in higher average throughput than ECMP with 3 subflows. This result signifies the importance of adaptive routing which our SDN architecture demonstrates. It also shows how hash collision of ECMP can affect the potential improvements of using MPTCP. Figures 5.13 and 5.14 show the CDF of completion time of large flows in TM1 and TM2. Higher average throughput leads to reducing flow completion time.

One interesting observation in TM1 is that the improvement of throughput was less than 1% when using 3 subflows compared to 2 subflows both with SDN routing. However, the improvement was around 4% in the TM2 case where we have higher number of large flows. This leads us to conclude that when the network is less congested it is probably a better trade-off to use fewer subflows.

There are many factors to consider when choosing the number of auxiliary subflows. These factors include network topology and how many paths that can be used by large flows. There is also a trade-off between the potential throughput gain and the overhead of creating additional subflow. Our SDN architecture demonstrates higher throughput gain with smaller number of subflows compared to ECMP.

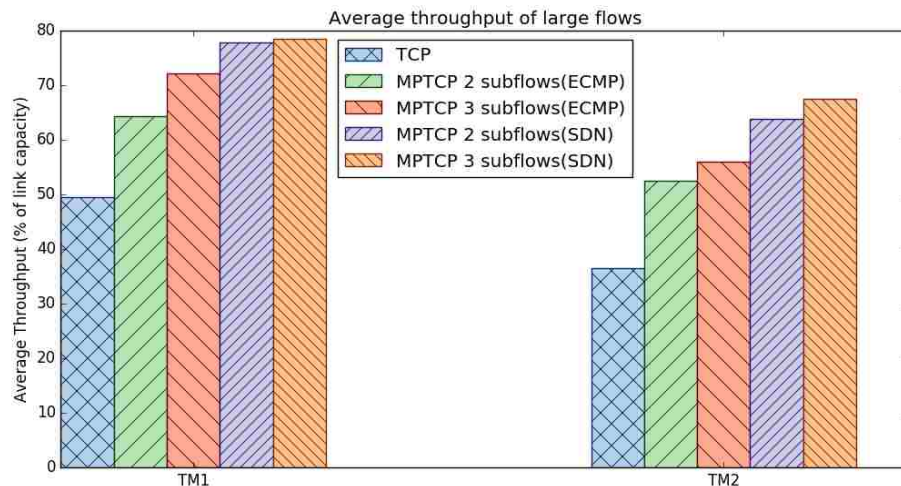

Figure 5.10: Average throughput of large flows

One of the main challenges that face any SDN architecture is the issue of scalability. SDN controller must be able to process incoming OpenFlow messages in a timely manner. A key design goal of our SDN architecture is reducing the number of OpenFlow messages as much as possible. Large flows constitute most of the transmitted traffic in data centers while the vast majority of flows are short [63]. By

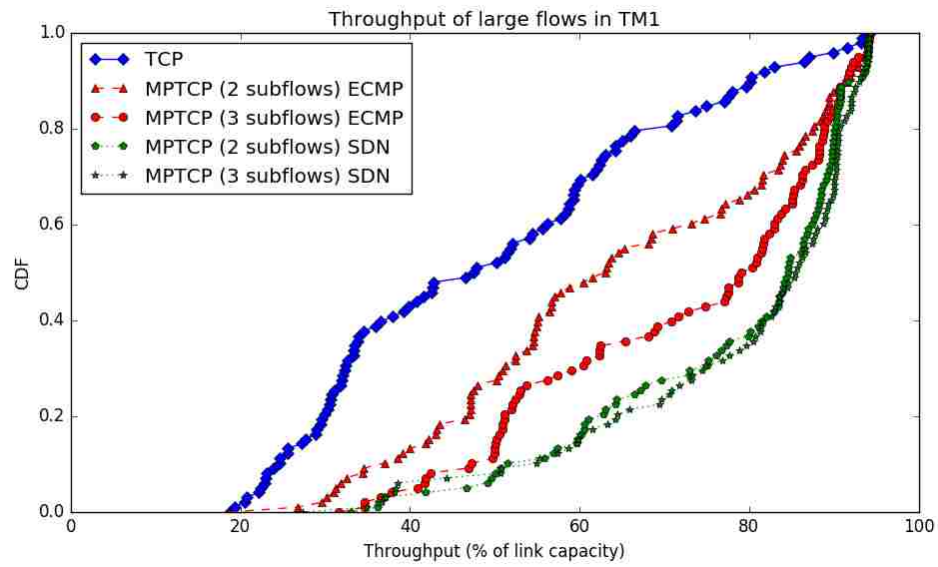

Figure 5.11: Throughput of large flows (TM1)

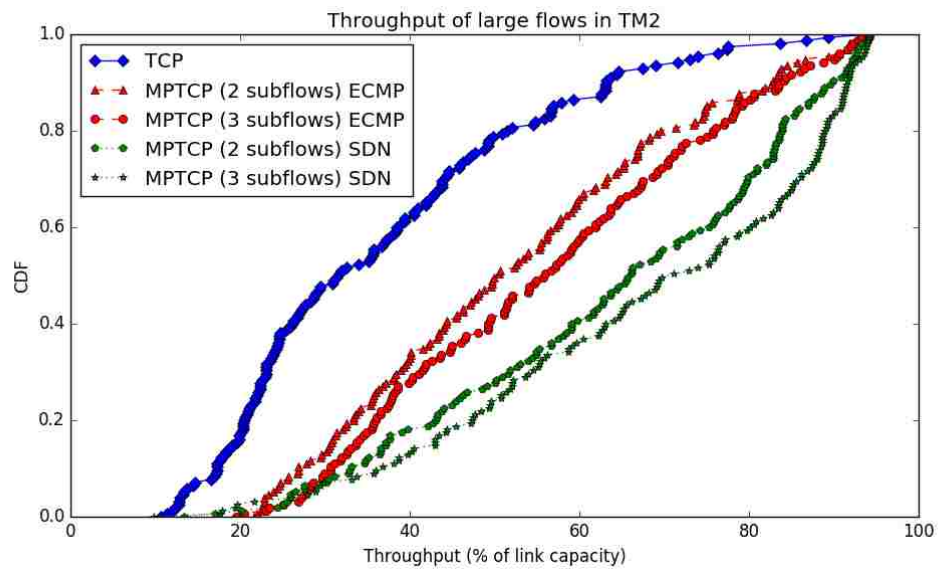

Figure 5.12: Throughput of large flows (TM2)

forwarding only the auxiliary subflows of large flows to the SDN controller, we reduce the number of OpenFlow messages. Hence, the load on SDN controller is minimized.

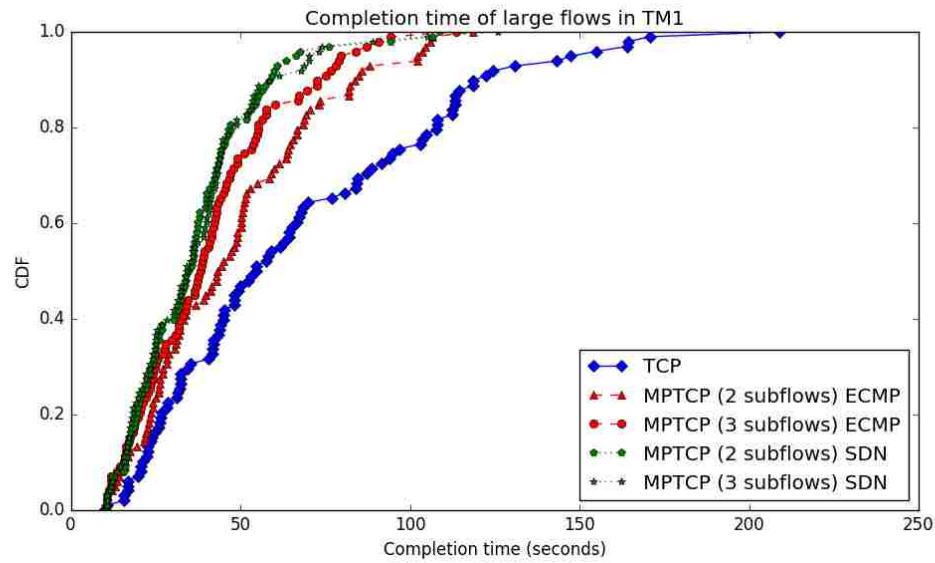

Figure 5.13: Completion time of large flows (TM1)

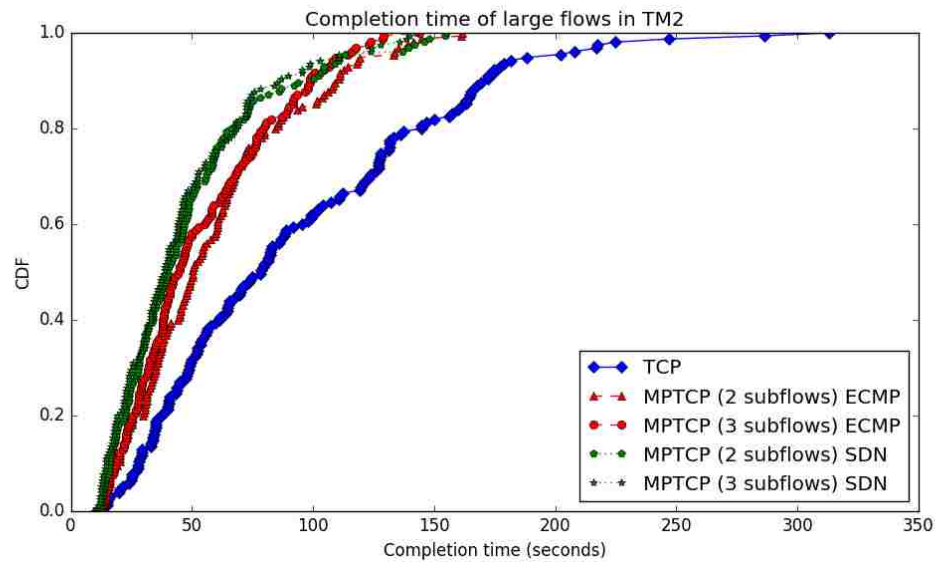

Figure 5.14: Completion time of large flows (TM2)

## 5.6 Summary

In this chapter, we proposed an SDN-based architecture for using MPTCP in data centers. In this architecture, additional MPTCP subflows are created on demand using the modified Linux kernel. Experiments were conducted on the GENI testbed

environment to evaluate the use of MPTCP and OpenFlow. We show that using a centralized controller can improve throughput of large flows, which leads to better utilization of network resources.

# Chapter 6

## Conclusion

In this dissertation, we have studied various mechanisms that aim to improve the quality of service provided to selected traffic flows. The main focus of this research is to develop convenient methods and systems that have the ability to provide various network applications with guaranteed quality of service. Our study focuses on certain types of network traffic flows that have different aspects of QoS requirements. Utilizing the software-defined networking architecture, we have developed and evaluated three mechanisms. In the following, we summarize the main contributions introduced in this research:

- An SDN-based QoS routing approach to improve the provisioning of quality of service to bandwidth-demanding traffic flows. By having a centralized controller that performs continuous monitoring of network measurements, the QoS routing application places traffic flows on paths that have sufficient available capacity. The evaluation results show that this approach can significantly improve the throughput of bandwidth-demanding flows, compared with the shortest path routing algorithm used in existing networks.
- A flexible framework for providing quality of service to latency-sensitive traffic. Latency, an important QoS measurement for various network applications, is

affected by the queuing delay of network devices and also by the current state of traversed path. Our SDN-based framework enables the timely delivery of data packets belonging to latency-sensitive traffic. This framework provides QoS to latency-sensitive traffic with the focus on defining priorities for different traffic classes and the assigning mechanism of unused network capacity.

- An SDN-based architecture for maximizing the throughput of large flows by using Multipath TCP. Traffic engineering in modern data center networks should leverage available multi-path topologies. By using Multipath TCP and SDN, we have developed a solution that maximizes throughput gain of large flows. Our approach enables applications to achieve higher throughput for large flows by dynamically creating multiple MPTCP subflows. These MPTCP subflows are routed through least-congested paths by the centralized SDN controller.

## 6.1 Future Work

There are several directions to extend the research presented in this dissertation. We list the following:

- Defining additional traffic flows with different characteristics. This can include traffic flows that have more than one parameter in their QoS requirements.
- Investigating the relationship between different QoS metrics. The inter-dependency of QoS metrics is an interesting topic for composite parameter QoS applications.
- Exploring different methods to gather network measurements. Instead of querying the data plane periodically for statistics, we could use a push model that exports such information. For example, we can use IPFIX protocol to

export statistics to a collector and then analyze them and perform actions related to QoS provisioning and monitoring.

- Adaptive SDN-based load balancing using OpenFlow group tables. In chapter 5, we used OpenFlow group tables for load balancing with fixed weights. This can be extended to employ an adaptive approach that adjusts the weights based on the current network measurements.



# Appendix

Lists of traffic flows used in the second experiment in Chapter 3.

**Start, duration:** in seconds

**BW:** iperf3 reported bandwidth in Kbps

Src	Dst	Start	Duration	Accepted	BW
h1	h18	14	200	Yes	9063
h15	h2	26	178	Yes	8784
h7	h17	41	189	Yes	6456
h11	h4	55	182	Yes	9473
h9	h13	69	197	No	6137
h20	h16	83	179	Yes	9516
h4	h5	95	160	Yes	7727
h19	h10	110	197	Yes	7590
h14	h19	122	176	No	9036
h16	h7	135	179	No	7974
h5	h1	148	162	No	8286
h3	h8	160	203	No	8530
h2	h9	171	203	No	8959
h6	h15	183	163	No	5891
h10	h20	197	209	No	9456
h12	h14	208	181	No	6238
h17	h11	222	188	No	7501
h13	h3	236	151	No	6920
h8	h12	248	159	Yes	9447
h18	h6	261	169	No	6224

Src	Dst	Start	Duration	Accepted	BW
h15	h5	13	135	Yes	9471
h20	h16	25	144	Yes	9566
h12	h18	40	166	Yes	9546
h7	h11	55	128	Yes	9315
h10	h7	67	139	Yes	9437
h2	h15	79	164	Yes	7060
h19	h1	93	137	Yes	7744
h1	h13	107	166	No	6257
h4	h12	122	162	Yes	9471
h18	h3	134	155	No	7918
h3	h6	146	95	No	3299
h14	h9	161	128	No	5371
h6	h19	175	91	No	3045
h8	h10	187	112	No	5568
h16	h2	198	149	No	5807
h5	h20	212	113	No	4656
h11	h17	223	65	Yes	8961
h9	h4	234	94	Yes	8491
h13	h8	245	105	No	7349
h17	h14	256	170	Yes	9355

Src	Dst	Start	Duration	Accepted	BW
h1	h14	14	150	Yes	9411
h14	h8	26	176	Yes	9159
h5	h12	39	123	Yes	9610
h13	h7	54	163	Yes	6681
h6	h16	68	139	Yes	6313
h4	h9	83	161	No	8188
h9	h6	98	180	No	6804
h19	h2	110	122	No	8209
h12	h20	124	165	No	7658
h10	h13	135	134	No	4629
h8	h15	147	137	No	7311
h16	h10	158	178	No	6757
h2	h18	169	135	No	3792
h15	h3	184	159	No	5033
h20	h4	197	168	No	4859
h7	h1	209	179	No	8980
h17	h11	223	155	No	4223
h11	h19	236	175	No	5080
h18	h5	250	124	No	3201
h3	h17	262	166	No	5798

Src	Dst	Start	Duration	Accepted	BW
h8	h2	11	147	Yes	9563
h18	h7	25	176	Yes	8783
h7	h13	38	154	Yes	7731
h16	h17	52	136	Yes	9144
h10	h15	66	116	Yes	9569
h14	h11	78	108	Yes	9527
h11	h6	89	168	Yes	8292
h5	h14	102	174	No	6829
h9	h16	113	70	No	3954
h15	h18	125	147	No	7911
h19	h12	140	155	No	7327
h12	h3	151	86	No	6647
h1	h19	166	141	No	5694
h6	h4	179	157	Yes	8589
h2	h5	191	76	No	6601
h13	h1	204	62	No	6225
h4	h20	215	119	Yes	4620
h17	h9	230	148	No	6069
h20	h8	244	151	No	6339
h3	h10	257	162	No	7441

Src	Dst	Start	Duration	Accepted	BW
h7	h3	14	150	Yes	8897
h6	h12	29	80	Yes	9566
h5	h16	41	138	Yes	9297
h19	h7	55	128	Yes	9223
h10	h6	69	102	Yes	9488
h14	h4	82	60	No	6591
h11	h19	97	118	Yes	7574
h13	h5	108	133	No	8856
h2	h18	120	81	No	6812
h17	h14	133	115	Yes	9519
h3	h13	148	67	No	7855
h20	h9	160	93	No	6631
h18	h1	172	108	No	6161
h12	h17	184	152	No	8145
h4	h10	197	78	No	9544
h16	h11	212	74	No	8072
h1	h8	227	120	No	9475
h8	h20	240	85	Yes	6251
h9	h15	253	101	Yes	7948
h15	h2	264	90	No	8256

Src	Dst	Start	Duration	Accepted	BW
h13	h11	14	110	Yes	9481
h17	h13	29	82	Yes	9485
h8	h19	43	69	Yes	6674
h15	h18	56	104	No	8765
h11	h15	67	101	No	8269
h4	h14	78	91	No	4179
h9	h7	91	81	Yes	7550
h20	h12	102	109	Yes	9544
h3	h9	113	78	Yes	9439
h2	h8	124	79	No	5718
h7	h16	135	92	Yes	9280
h12	h2	150	101	No	8579
h14	h4	162	102	Yes	7801
h1	h10	173	81	No	7928
h10	h1	188	100	No	6683
h16	h5	199	84	No	6577
h18	h3	211	70	No	3574
h6	h20	222	79	Yes	9490
h5	h17	237	72	Yes	9452
h19	h6	249	69	No	9292

Src	Dst	Start	Duration	Accepted	BW
h6	h13	13	68	Yes	9572
h1	h18	24	84	Yes	7840
h10	h19	38	64	No	6725
h2	h8	53	70	Yes	9569
h12	h4	66	60	Yes	9577
h19	h2	80	86	Yes	8110
h7	h14	93	81	Yes	9574
h16	h11	105	61	Yes	8758
h4	h10	120	86	Yes	9556
h14	h3	134	68	No	7030
h5	h20	148	63	No	8760
h17	h9	163	87	No	6828
h20	h12	174	79	No	7412
h15	h17	189	88	Yes	9446
h9	h15	204	62	Yes	9431
h13	h6	216	73	Yes	9577
h8	h1	231	75	Yes	9647
h11	h5	243	80	Yes	8177
h18	h16	257	73	Yes	9574
h3	h7	271	65	No	7394

Src	Dst	Start	Duration	Accepted	BW
h6	h15	22	88	Yes	9306
h17	h7	41	82	Yes	9553
h4	h5	57	89	Yes	9317
h3	h20	75	72	Yes	9553
h5	h14	93	88	No	7185
h15	h17	107	78	Yes	9560
h2	h13	124	69	No	7686
h8	h19	145	66	No	9459
h11	h2	169	62	Yes	9578
h18	h9	191	75	Yes	9582
h1	h8	216	68	Yes	9576
h9	h4	240	69	Yes	9263
h12	h16	256	63	Yes	9609
h14	h11	274	75	Yes	8940
h20	h6	291	77	No	8776
h16	h10	316	84	No	7106
h13	h12	341	82	No	7080
h19	h3	359	74	No	8968
h10	h18	374	82	Yes	9195
h7	h1	387	69	Yes	9579

Src	Dst	Start	Duration	Accepted	BW
h9	h16	11	79	Yes	8190
h16	h9	25	62	Yes	9546
h5	h11	37	102	Yes	8435
h8	h15	52	70	No	8474
h3	h18	63	102	No	6978
h11	h8	77	96	Yes	7623
h10	h2	89	103	No	6103
h12	h5	101	70	No	9574
h20	h7	114	91	Yes	8760
h19	h3	126	68	No	3570
h1	h6	139	72	No	8765
h4	h17	151	113	No	8747
h18	h13	165	71	No	7820
h2	h14	179	91	No	8418
h13	h19	194	93	Yes	7297
h17	h1	207	77	No	9076
h7	h4	222	87	Yes	7584
h14	h12	234	120	No	4755
h6	h10	249	113	No	5638
h15	h20	262	76	No	8108

Src	Dst	Start	Duration	Accepted	BW
h15	h17	15	70	Yes	9571
h3	h19	29	73	Yes	9174
h16	h3	43	89	Yes	9512
h9	h13	54	73	Yes	8912
h19	h2	69	72	Yes	9353
h5	h18	81	70	No	7991
h12	h16	96	82	No	6351
h1	h11	108	79	No	9581
h6	h15	123	76	No	7826
h13	h10	134	75	No	7339
h8	h4	148	68	Yes	9631
h11	h5	160	62	Yes	9035
h4	h12	173	87	No	8834
h17	h9	185	77	Yes	8231
h2	h8	197	85	No	8449
h18	h6	211	62	No	7229
h10	h14	223	85	Yes	9467
h14	h1	235	86	Yes	9401
h20	h7	250	63	No	7590
h7	h20	265	77	Yes	8201

Src	Dst	Start	Duration	Accepted	BW
h15	h5	24	62	Yes	9571
h5	h13	47	62	Yes	9450
h13	h11	62	75	Yes	9472
h19	h16	77	67	Yes	9566
h11	h4	100	88	Yes	9509
h16	h1	124	86	Yes	9520
h18	h10	146	86	No	9572
h3	h8	161	70	Yes	9565
h9	h20	185	89	Yes	9561
h1	h19	203	83	Yes	7818
h12	h3	216	84	Yes	9562
h10	h14	231	66	No	7850
h6	h18	255	89	No	7666
h2	h7	270	74	Yes	9572
h7	h9	285	67	No	5855
h8	h17	307	62	Yes	9568
h14	h12	332	89	Yes	9573
h17	h2	348	86	Yes	8218
h20	h6	371	84	No	7315
h4	h15	392	83	Yes	9570

Src	Dst	Start	Duration	Accepted	BW
h12	h3	19	86	Yes	9573
h11	h5	40	77	Yes	9562
h2	h16	55	76	Yes	9568
h6	h20	75	88	Yes	9338
h14	h11	95	73	Yes	9562
h3	h12	118	75	Yes	9575
h7	h17	143	90	No	8705
h20	h10	157	69	No	8478
h17	h9	174	87	No	6805
h4	h15	191	80	Yes	9576
h10	h2	211	85	Yes	9533
h8	h1	235	88	Yes	9575
h19	h13	249	79	Yes	9574
h16	h6	265	75	Yes	9577
h13	h18	290	82	Yes	9470
h18	h7	312	82	Yes	9481
h9	h19	332	79	Yes	9575
h1	h14	353	67	Yes	9572
h5	h4	375	89	Yes	9574
h15	h8	393	67	Yes	9576

Src	Dst	Start	Duration	Accepted	BW
h9	h16	25	63	Yes	9565
h4	h9	48	88	Yes	9564
h5	h2	63	86	Yes	9037
h3	h12	78	83	Yes	9504
h15	h10	98	88	Yes	9571
h8	h3	115	61	No	7619
h13	h5	140	86	Yes	9570
h6	h14	165	89	Yes	9434
h18	h6	186	64	No	8474
h19	h4	201	82	No	6954
h16	h20	222	61	Yes	9566
h20	h15	237	72	Yes	9443
h17	h8	254	85	No	7828
h10	h1	276	89	No	9484
h12	h7	295	63	No	7437
h1	h17	317	69	Yes	7465
h11	h18	332	64	No	7152
h7	h11	351	72	Yes	9072
h14	h19	374	83	Yes	9573
h2	h13	388	88	Yes	9577

Src	Dst	Start	Duration	Accepted	BW
h5	h3	22	79	Yes	9573
h10	h6	47	78	Yes	9570
h11	h2	67	76	Yes	9573
h1	h15	85	70	Yes	9572
h8	h9	103	77	Yes	9574
h2	h5	121	74	Yes	8920
h16	h17	141	68	Yes	9280
h3	h12	164	68	No	8122
h15	h19	184	79	No	8270
h20	h16	205	61	Yes	9203
h14	h18	229	80	Yes	9586
h18	h10	250	62	Yes	9451
h19	h14	270	72	No	9343
h6	h13	295	78	Yes	9567
h17	h8	319	73	No	9573
h9	h20	344	71	Yes	9575
h13	h11	364	71	Yes	9552
h12	h4	386	75	Yes	9563
h4	h7	408	66	Yes	9416
h7	h1	430	71	Yes	9477

Src	Dst	Start	Duration	Accepted	BW
h13	h18	16	185	Yes	9418
h18	h15	32	203	Yes	9408
h8	h17	51	192	Yes	6632
h3	h13	67	169	Yes	9091
h1	h9	85	203	Yes	9333
h6	h12	101	201	No	6361
h5	h11	119	160	No	4489
h7	h2	137	197	Yes	8241
h9	h19	157	201	No	8958
h4	h5	176	150	No	7804
h16	h3	193	210	No	6407
h11	h14	209	189	No	7663
h14	h4	227	154	Yes	6564
h2	h20	244	179	No	6762
h12	h1	262	168	No	8597
h15	h8	280	160	No	7669
h19	h10	297	166	No	8080
h17	h6	316	179	No	3509
h10	h7	332	185	No	7610
h20	h16	350	194	Yes	9518

Src	Dst	Start	Duration	Accepted	BW
h7	h1	20	128	Yes	9493
h8	h13	39	125	Yes	9485
h19	h7	57	126	Yes	9282
h14	h6	76	179	Yes	9524
h1	h8	92	128	Yes	9252
h12	h2	109	165	Yes	8975
h15	h17	128	175	Yes	7249
h17	h11	145	143	No	7418
h10	h14	163	126	Yes	9506
h16	h19	179	133	No	8038
h3	h15	196	152	No	8016
h18	h5	215	168	No	6726
h11	h4	232	162	No	8969
h2	h18	248	178	No	6888
h20	h10	265	126	No	6427
h6	h16	285	149	No	8603
h5	h3	302	162	Yes	9484
h13	h12	319	161	Yes	8909
h9	h20	335	167	No	7648
h4	h9	354	160	No	8540

Src	Dst	Start	Duration	Accepted	BW
h10	h6	22	73	Yes	9576
h11	h5	47	72	Yes	9571
h2	h7	65	69	Yes	7348
h3	h19	88	63	No	8615
h13	h17	111	76	Yes	9573
h6	h14	131	84	Yes	9570
h5	h20	149	80	No	9302
h4	h10	174	67	Yes	9573
h20	h3	194	68	Yes	9361
h8	h11	219	72	No	8987
h17	h15	239	77	Yes	9569
h15	h12	257	90	Yes	9436
h16	h4	282	74	Yes	8201
h18	h9	303	78	No	7594
h1	h18	324	79	Yes	7683
h14	h1	345	85	No	9442
h12	h13	366	86	Yes	8581
h19	h16	391	74	Yes	9580
h9	h8	411	71	No	7772
h7	h2	429	70	Yes	9579

Src	Dst	Start	Duration	Accepted	BW
h14	h4	22	77	Yes	9570
h17	h1	43	62	Yes	9565
h3	h15	68	68	Yes	9567
h5	h10	91	64	Yes	9570
h8	h3	111	70	Yes	9560
h2	h17	134	67	Yes	9572
h16	h5	158	70	Yes	9575
h13	h8	182	73	Yes	9574
h1	h18	206	68	Yes	9579
h15	h9	231	77	No	8236
h7	h12	256	73	No	7622
h19	h16	279	63	Yes	9562
h18	h6	301	79	Yes	9119
h9	h19	326	62	Yes	9571
h11	h20	345	62	Yes	8693
h10	h14	370	70	No	8012
h12	h2	393	66	No	9242
h4	h13	413	78	Yes	9569
h20	h7	436	80	No	9222
h6	h11	459	71	Yes	9569

Src	Dst	Start	Duration	Accepted	BW
h5	h2	20	165	Yes	9565
h18	h10	39	205	Yes	7168
h8	h19	57	191	Yes	7996
h4	h14	75	203	Yes	7913
h20	h11	94	187	No	5164
h11	h18	111	186	No	5952
h19	h1	131	201	No	5828
h16	h20	148	168	No	8524
h14	h3	167	171	Yes	6929
h15	h5	186	209	No	6833
h2	h13	202	199	No	8579
h9	h16	221	183	No	3420
h3	h17	239	172	No	5273
h10	h7	255	161	Yes	6791
h13	h4	275	157	No	5530
h7	h9	292	154	Yes	4566
h17	h8	310	163	No	5337
h1	h12	326	166	No	6778
h12	h6	345	160	No	5585
h6	h15	365	164	No	7967

Src	Dst	Start	Duration	Accepted	BW
h10	h18	20	136	Yes	9402
h8	h10	38	135	Yes	9346
h13	h7	56	126	Yes	7966
h17	h5	72	145	Yes	9576
h14	h1	90	174	No	7391
h15	h19	107	122	Yes	9551
h4	h12	127	141	Yes	8960
h6	h11	144	125	No	8568
h16	h2	162	167	No	7392
h19	h16	179	124	Yes	8867
h2	h15	195	179	Yes	6963
h3	h9	215	176	No	8563
h18	h4	232	158	Yes	7739
h20	h14	249	167	No	8340
h12	h20	266	138	Yes	8601
h7	h13	283	168	No	8682
h9	h3	301	156	No	7530
h11	h6	319	162	Yes	9570
h1	h8	336	156	No	9372
h5	h17	353	134	No	8686

Src	Dst	Start	Duration	Accepted	BW
h17	h12	18	129	Yes	9427
h7	h17	38	171	Yes	7305
h11	h14	54	121	Yes	9372
h13	h20	74	129	No	7592
h1	h10	92	168	Yes	8626
h16	h6	110	144	Yes	7945
h15	h5	128	160	No	7245
h4	h19	148	122	No	6291
h20	h1	168	138	Yes	7506
h8	h4	185	142	Yes	8252
h5	h2	202	135	No	6416
h19	h9	218	170	No	7830
h12	h13	237	121	Yes	5933
h10	h8	255	155	Yes	6269
h9	h16	275	128	No	3793
h18	h15	295	136	Yes	9469
h6	h18	311	138	Yes	6048
h14	h3	329	152	Yes	7875
h3	h11	346	158	Yes	9404
h2	h7	363	130	Yes	9571

Src	Dst	Start	Duration	Accepted	BW
h4	h8	16	158	Yes	9405
h20	h3	34	113	Yes	9465
h12	h1	52	111	Yes	9367
h14	h7	71	119	Yes	8430
h17	h13	90	109	Yes	9566
h15	h9	109	157	No	6840
h11	h16	126	136	No	3447
h6	h18	144	160	Yes	8103
h5	h15	163	151	No	3661
h13	h6	180	159	No	7768
h18	h2	197	123	Yes	9476
h9	h20	216	117	Yes	7743
h10	h17	233	149	No	6880
h7	h12	250	100	Yes	9107
h1	h5	266	141	Yes	9037
h16	h4	283	117	No	7012
h8	h11	303	114	Yes	9574
h2	h19	323	121	No	7923
h19	h10	339	158	Yes	8807
h3	h14	356	123	No	8201

Src	Dst	Start	Duration	Accepted	BW
h20	h11	17	160	Yes	9568
h7	h3	34	158	Yes	9545
h13	h18	50	132	Yes	9567
h1	h8	66	147	Yes	8265
h19	h14	83	139	Yes	9570
h4	h7	100	158	Yes	9229
h8	h17	117	155	Yes	7293
h2	h5	136	124	No	8049
h6	h9	155	108	No	7641
h11	h6	172	141	No	6367
h16	h10	190	101	No	8886
h5	h1	209	115	Yes	7036
h10	h19	227	156	No	7389
h9	h20	243	117	No	6255
h15	h2	263	149	No	6913
h12	h16	281	111	Yes	8258
h18	h15	299	147	Yes	9495
h17	h12	316	123	Yes	8942
h3	h13	334	121	No	8153
h14	h4	353	102	No	7813

Src	Dst	Start	Duration	Accepted	BW
h8	h13	20	71	Yes	9561
h2	h5	44	91	Yes	9576
h9	h8	69	88	Yes	9570
h11	h4	93	85	Yes	9574
h10	h3	114	79	Yes	8788
h18	h15	138	71	No	6781
h5	h11	161	99	Yes	9570
h16	h17	184	95	Yes	7719
h13	h9	204	83	Yes	6541
h17	h12	225	96	Yes	9187
h3	h7	248	100	Yes	9503
h7	h19	272	97	Yes	9102
h19	h16	297	74	No	8223
h4	h18	319	70	No	6482
h6	h14	344	76	Yes	9562
h20	h1	364	86	Yes	9394
h12	h20	389	71	No	9366
h14	h2	410	92	Yes	8111
h15	h10	435	94	No	7352
h1	h6	458	81	Yes	9561

Src	Dst	Start	Duration	Accepted	BW
h13	h20	20	125	Yes	9567
h1	h5	38	124	Yes	8124
h17	h14	57	129	Yes	9568
h4	h6	77	140	Yes	9218
h3	h7	97	112	No	8495
h18	h2	114	134	Yes	7829
h15	h9	130	115	Yes	8818
h19	h12	148	106	No	7300
h7	h18	166	135	Yes	6778
h10	h8	182	113	No	8233
h16	h10	201	104	No	8137
h2	h11	220	116	No	9480
h5	h4	238	108	Yes	9572
h11	h13	257	110	Yes	9327
h12	h16	277	137	No	6176
h6	h15	297	106	No	6556
h20	h3	317	157	Yes	7179
h9	h1	333	148	No	7561
h8	h19	349	116	No	8934
h14	h17	365	159	Yes	9566

Src	Dst	Start	Duration	Accepted	BW
h11	h16	17	159	Yes	7325
h17	h15	36	122	Yes	9564
h14	h9	54	101	Yes	9536
h9	h18	72	121	No	5343
h6	h20	90	133	No	5771
h19	h13	109	102	No	9441
h10	h4	127	119	Yes	9460
h4	h6	146	111	Yes	8524
h3	h11	165	116	Yes	9565
h15	h1	184	145	Yes	9567
h2	h5	204	125	No	8241
h12	h7	221	123	Yes	9563
h8	h19	239	110	Yes	9572
h5	h2	259	118	Yes	6880
h18	h14	278	128	Yes	9570
h7	h12	297	130	No	5782
h13	h10	314	138	No	5750
h1	h17	330	153	Yes	9603
h20	h8	346	137	No	5782
h16	h3	363	123	Yes	7961

Src	Dst	Start	Duration	Accepted	BW
h6	h15	16	90	Yes	9403
h4	h10	34	100	Yes	8918
h1	h13	52	82	Yes	7630
h2	h11	68	89	No	6807
h3	h14	84	105	No	8418
h8	h17	102	85	No	9101
h12	h6	122	104	Yes	8735
h10	h4	139	112	Yes	8559
h19	h8	156	114	Yes	7955
h9	h1	176	102	No	6376
h16	h3	195	113	No	7766
h18	h2	215	82	No	4754
h5	h20	234	114	Yes	8453
h11	h7	252	85	Yes	9575
h14	h12	270	80	No	7550
h15	h19	288	116	No	8148
h17	h16	308	113	Yes	8179
h13	h5	326	83	No	8460
h7	h18	342	110	Yes	9572
h20	h9	362	103	Yes	9570

Src	Dst	Start	Duration	Accepted	BW
h3	h6	22	79	Yes	9568
h20	h14	47	85	Yes	9564
h4	h10	70	93	Yes	9569
h16	h18	91	89	Yes	9572
h17	h13	115	80	Yes	9511
h2	h20	136	85	Yes	8229
h7	h17	160	90	No	7450
h12	h8	185	96	No	6413
h19	h5	208	89	Yes	6613
h15	h9	228	77	Yes	6595
h14	h7	253	71	Yes	7524
h5	h3	276	79	Yes	7920
h11	h2	301	98	No	7525
h8	h19	323	96	Yes	9572
h9	h4	347	83	Yes	8966
h10	h15	372	77	Yes	9575
h6	h1	397	72	No	7974
h1	h11	420	84	Yes	9437
h18	h16	441	91	Yes	9574
h13	h12	463	88	Yes	9568

Src	Dst	Start	Duration	Accepted	BW
h14	h3	23	87	Yes	9074
h16	h19	47	96	Yes	9573
h15	h1	67	70	No	7184
h2	h16	92	92	Yes	8522
h11	h8	112	82	Yes	9575
h1	h9	137	95	Yes	9567
h7	h11	162	73	Yes	8515
h5	h18	184	81	No	7544
h13	h2	206	74	Yes	9577
h18	h7	231	78	Yes	7163
h19	h4	255	86	Yes	6013
h17	h10	276	84	No	5232
h8	h12	298	96	Yes	9484
h12	h13	319	75	Yes	9441
h20	h6	341	72	No	8357
h4	h20	364	93	Yes	6805
h3	h5	385	70	Yes	7519
h6	h15	405	98	No	7171
h10	h17	429	81	No	7374
h9	h14	453	91	No	9296

Src	Dst	Start	Duration	Accepted	BW
h11	h19	22	77	Yes	9568
h3	h7	42	72	Yes	9561
h17	h8	62	95	Yes	8362
h14	h12	83	91	Yes	9564
h18	h2	108	90	No	8231
h2	h13	131	93	Yes	9168
h7	h10	156	95	Yes	9196
h5	h15	180	82	No	7374
h19	h9	200	98	Yes	9575
h6	h4	220	100	No	8312
h15	h11	243	86	Yes	7585
h1	h17	265	88	Yes	9573
h13	h20	287	96	No	8107
h20	h14	310	93	Yes	7728
h8	h3	330	77	Yes	9578
h16	h18	354	92	No	8191
h10	h1	379	86	Yes	9575
h4	h16	401	89	Yes	9563
h12	h5	423	88	Yes	9571
h9	h6	448	82	Yes	9571

# Bibliography

- [1] ITU-T, “One way transmission time, itu-t recommendation g. 114,” 2003. Available at <https://www.itu.int/rec/T-REC-G.114-200305-I>.
- [2] R. Braden, D. Clark, and S. Shenker, “Integrated services in the internet architecture: an overview. rfc 1633,” 1994.
- [3] L. Zhang, S. Berson, S. Herzog, and S. Jamin, “Resource reservation protocol (rsvp)–version 1 functional specification. rfc 2205,” 1997.
- [4] X. Xiao and L. M. Ni, “Internet qos: A big picture,” *IEEE network*, vol. 13, no. 2, pp. 8–18, 1999.
- [5] K. Nichols, D. L. Black, S. Blake, and F. Baker, “Definition of the differentiated services field (ds field) in the ipv4 and ipv6 headers. rfc 2474,” 1998.
- [6] Z. Wang and J. Crowcroft, “Quality-of-service routing for supporting multimedia applications,” *IEEE Journal on selected areas in communications*, vol. 14, no. 7, pp. 1228–1234, 1996.
- [7] S. Chen and K. Nahrstedt, “An overview of quality of service routing for next-generation high-speed networks: problems and solutions,” *IEEE network*, vol. 12, no. 6, pp. 64–79, 1998.
- [8] M. Curado and E. Monteiro, “A survey of qos routing algorithms,” in *Proceedings of the International Conference on Information Technology (ICIT 2004), Istanbul, Turkey, 2004*.
- [9] F. Kuipers, P. Van Mieghem, T. Korkmaz, and M. Krunz, “An overview of constraint-based path selection algorithms for qos routing,” *IEEE Communications Magazine*, vol. 40, no. 12, pp. 50–55, 2002.
- [10] T. Korkmaz and M. Krunz, “Multi-constrained optimal path selection,” in *IEEE INFOCOM*, vol. 2, pp. 834–843, Citeseer, 2001.
- [11] A. Juttner, B. Szviatovski, I. Mécs, and Z. Rajkó, “Lagrange relaxation based method for the qos routing problem,” in *INFOCOM 2001. Twentieth Annual Joint Conference of the IEEE Computer and Communications Societies. Proceedings. IEEE*, vol. 2, pp. 859–868, IEEE, 2001.

- [12] X. Masip-Bruin, M. Yannuzzi, J. Domingo-Pascual, A. Fonte, M. Curado, E. Monteiro, F. Kuipers, P. Van Mieghem, S. Avallone, G. Ventre, *et al.*, “Research challenges in qos routing,” *Computer communications*, vol. 29, no. 5, pp. 563–581, 2006.
- [13] S. Chen, M. Song, and S. Sahni, “Two techniques for fast computation of constrained shortest paths,” *IEEE/ACM Transactions on Networking (TON)*, vol. 16, no. 1, pp. 105–115, 2008.
- [14] D. Kreutz, F. M. Ramos, P. E. Verissimo, C. E. Rothenberg, S. Azodolmolky, and S. Uhlig, “Software-defined networking: A comprehensive survey,” *Proceedings of the IEEE*, vol. 103, no. 1, pp. 14–76, 2015.
- [15] N. Feamster, J. Rexford, and E. Zegura, “The road to sdn: an intellectual history of programmable networks,” *ACM SIGCOMM Computer Communication Review*, vol. 44, no. 2, pp. 87–98, 2014.
- [16] M. Caesar, D. Caldwell, N. Feamster, J. Rexford, A. Shaikh, and J. van der Merwe, “Design and implementation of a routing control platform,” in *Proceedings of the 2Nd Conference on Symposium on Networked Systems Design and Implementation-Volume 2*, pp. 15–28, USENIX Association, 2005.
- [17] A. Greenberg, G. Hjalmtysson, D. A. Maltz, A. Myers, J. Rexford, G. Xie, H. Yan, J. Zhan, and H. Zhang, “A clean slate 4d approach to network control and management,” *ACM SIGCOMM Computer Communication Review*, vol. 35, no. 5, pp. 41–54, 2005.
- [18] M. Casado, M. J. Freedman, J. Pettit, J. Luo, N. McKeown, and S. Shenker, “Ethane: Taking control of the enterprise,” in *ACM SIGCOMM Computer Communication Review*, vol. 37, pp. 1–12, ACM, 2007.
- [19] M. Casado, T. Garfinkel, A. Akella, M. J. Freedman, D. Boneh, N. McKeown, and S. Shenker, “Sane: A protection architecture for enterprise networks,” in *USENIX Security Symposium*, vol. 49, pp. 137–151, 2006.
- [20] N. McKeown, T. Anderson, H. Balakrishnan, G. Parulkar, L. Peterson, J. Rexford, S. Shenker, and J. Turner, “Openflow: enabling innovation in campus networks,” *ACM SIGCOMM Computer Communication Review*, vol. 38, no. 2, pp. 69–74, 2008.
- [21] B. A. A. Nunes, M. Mendonca, X.-N. Nguyen, K. Obraczka, and T. Turletti, “A survey of software-defined networking: Past, present, and future of programmable networks,” *IEEE Communications Surveys & Tutorials*, vol. 16, no. 3, pp. 1617–1634, 2014.
- [22] B. Pfaff, J. Pettit, T. Koponen, E. J. Jackson, A. Zhou, J. Rajahalme, J. Gross, A. Wang, J. Stringer, P. Shelar, *et al.*, “The design and implementation of open vswitch,” in *NSDI*, pp. 117–130, 2015.

- [23] B. Pfaff, J. Pettit, K. Amidon, M. Casado, T. Koponen, and S. Shenker, “Extending networking into the virtualization layer,” in *Hotnets*, 2009.
- [24] “Floodlight,” 2017. Available at <http://www.projectfloodlight.org>.
- [25] H. E. Egilmez, S. T. Dane, K. T. Bagci, and A. M. Tekalp, “Openqos: An openflow controller design for multimedia delivery with end-to-end quality of service over software-defined networks,” in *Signal & Information processing association annual summit and conference (APSIPA ASC), 2012 Asia-Pacific*, pp. 1–8, IEEE, 2012.
- [26] H. Owens II and A. Durresi, “Video over software-defined networking (vsdn),” *Computer Networks*, vol. 92, pp. 341–356, 2015.
- [27] O. N. F. (ONF), “Openflow switch specification 1.5.1,” 2015. Available at <https://www.opennetworking.org/wp-content/uploads/2014/10/openflow-switch-v1.5.1.pdf>.
- [28] D. Erickson, “The beacon openflow controller,” in *Proceedings of the second ACM SIGCOMM workshop on Hot topics in software defined networking*, pp. 13–18, ACM, 2013.
- [29] “Mininet,” 2017. Available at <http://mininet.org/>.
- [30] “iperf3,” 2017. Available at <https://iperf.fr/>.
- [31] N. L. Van Adrichem, C. Doerr, and F. A. Kuipers, “Opennetmon: Network monitoring in openflow software-defined networks,” in *Network Operations and Management Symposium (NOMS), 2014 IEEE*, pp. 1–8, IEEE, 2014.
- [32] P. E. McKenney, “Stochastic fairness queueing,” in *INFOCOM’90, Ninth Annual Joint Conference of the IEEE Computer and Communication Societies. The Multiple Facets of Integration. Proceedings, IEEE*, pp. 733–740, IEEE, 1990.
- [33] “Htb,” 2017. Available at <http://luxik.cdi.cz/~devik/qos/htb/index.htm>.
- [34] I. Stoica, H. Zhang, and T. Ng, *A hierarchical fair service curve algorithm for link-sharing, real-time and priority services*, vol. 27. ACM, 1997.
- [35] R. Wallner and R. Cannistra, “An sdn approach: quality of service using big switches floodlight open-source controller,” *Proceedings of the Asia-Pacific Advanced Network*, vol. 35, pp. 14–19, 2013.
- [36] D. Palma, J. Gonçalves, B. Sousa, L. Cordeiro, P. Simoes, S. Sharma, and D. Staessens, “The queupusher: Enabling queue management in openflow,” in *Software Defined Networks (EWSDN), 2014 Third European Workshop on*, pp. 125–126, IEEE, 2014.



- [37] C. Caba and J. Soler, “Apis for qos configuration in software defined networks,” in *Network Softwarization (NetSoft), 2015 1st IEEE Conference on*, pp. 1–5, IEEE, 2015.
- [38] O. N. Foundation, “Openflow management and configuration protocol,” 2014. Available at <https://www.opennetworking.org/images/stories/downloads/sdn-resources/onf-specifications/openflow-config/of-config-1.2.pdf>.
- [39] B. Pfaff and B. Davie, “The open vswitch database management protocol. rfc 7047.” 2013.
- [40] “Json-rpc 1.0 specification,” 2005. Available at [http://www.jsonrpc.org/specification\\_v1](http://www.jsonrpc.org/specification_v1).
- [41] “Open vswitch database schema,” 2017. Available at <http://www.openvswitch.org/ovs-vswitchd.conf.db.5.pdf>.
- [42] M. Berman, J. S. Chase, L. Landweber, A. Nakao, M. Ott, D. Raychaudhuri, R. Ricci, and I. Seskar, “Geni: A federated testbed for innovative network experiments,” *Computer Networks*, vol. 61, pp. 5–23, 2014.
- [43] M. Al-Fares, S. Radhakrishnan, B. Raghavan, N. Huang, and A. Vahdat, “Hedera: Dynamic flow scheduling for data center networks.” in *NSDI*, vol. 10, pp. 19–19, 2010.
- [44] D. Wischik, C. Raiciu, A. Greenhalgh, and M. Handley, “Design, implementation and evaluation of congestion control for multipath tcp.” in *NSDI*, vol. 11, pp. 8–8, 2011.
- [45] M. Al-Fares, A. Loukissas, and A. Vahdat, “A scalable, commodity data center network architecture,” in *ACM SIGCOMM Computer Communication Review*, vol. 38, pp. 63–74, ACM, 2008.
- [46] C. Clos, “A study of non-blocking switching networks,” *Bell Labs Technical Journal*, vol. 32, no. 2, pp. 406–424, 1953.
- [47] C. Guo, G. Lu, D. Li, H. Wu, X. Zhang, Y. Shi, C. Tian, Y. Zhang, and S. Lu, “Bcube: a high performance, server-centric network architecture for modular data centers,” *ACM SIGCOMM Computer Communication Review*, vol. 39, no. 4, pp. 63–74, 2009.
- [48] A. Singla, C.-Y. Hong, L. Popa, and P. B. Godfrey, “Jellyfish: Networking data centers randomly.” in *NSDI*, vol. 12, pp. 17–17, 2012.
- [49] A. Greenberg, J. R. Hamilton, N. Jain, S. Kandula, C. Kim, P. Lahiri, D. A. Maltz, P. Patel, and S. Sengupta, “V12: a scalable and flexible data center network,” in *ACM SIGCOMM computer communication review*, vol. 39, pp. 51–62, ACM, 2009.

- [50] A. Ford, C. Raiciu, M. Handley, and O. Bonaventure, “Tcp extensions for multipath operation with multiple addresses. rfc 6824,” 2013.
- [51] V. Paxson, M. Allman, J. Chu, and M. Sargent, “Computing tcp’s retransmission timer. rfc 6298,” 2011.
- [52] C. Raiciu, M. Handley, and D. Wischik, “Coupled congestion control for multipath transport protocols. rfc 6356,” 2011.
- [53] A. R. Curtis, W. Kim, and P. Yalagandula, “Mahout: Low-overhead datacenter traffic management using end-host-based elephant detection,” in *INFOCOM, 2011 Proceedings IEEE*, pp. 1629–1637, IEEE, 2011.
- [54] A. Agache and C. Raiciu, “Oh flow, are thou happy? tcp sendbuffer advertising for make benefit of clouds and tenants.,” in *HotCloud*, 2015.
- [55] C. Raiciu, S. Barre, C. Pluntke, A. Greenhalgh, D. Wischik, and M. Handley, “Improving datacenter performance and robustness with multipath tcp,” in *ACM SIGCOMM Computer Communication Review*, vol. 41, pp. 266–277, ACM, 2011.
- [56] M. Sandri, A. Silva, L. A. Rocha, and F. L. Verdi, “On the benefits of using multipath tcp and openflow in shared bottlenecks,” in *Advanced Information Networking and Applications (AINA), 2015 IEEE 29th International Conference on*, pp. 9–16, IEEE, 2015.
- [57] S. Zannettou, M. Sirivianos, and F. Papadopoulos, “Exploiting path diversity in datacenters using mptcp-aware sdn,” in *Computers and Communication (ISCC), 2016 IEEE Symposium on*, pp. 539–546, IEEE, 2016.
- [58] M. Kheirhah, I. Wakeman, and G. Parisi, “Mmptcp: A multipath transport protocol for data centers,” in *Computer Communications, IEEE INFOCOM 2016-The 35th Annual IEEE International Conference on*, pp. 1–9, IEEE, 2016.
- [59] IANA, “Differentiated services field codepoints (dscp),” 2017. Available at <https://www.iana.org/assignments/dscp-registry/dscp-registry.xhtml>.
- [60] IANA, “Transmission control protocol (tcp) parameters,” 2017. Available at <https://www.iana.org/assignments/tcp-parameters/tcp-parameters.xhtml>.
- [61] C. Paasch, S. Barre, *et al.*, “Multipath tcp in the linux kernel,” 2013. Available at <https://www.multipath-tcp.org>.
- [62] B. Hesmans and O. Bonaventure, “An enhanced socket api for multipath tcp.,” in *ANRW*, pp. 1–6, 2016.
- [63] T. Benson, A. Akella, and D. A. Maltz, “Network traffic characteristics of data centers in the wild,” in *Proceedings of the 10th ACM SIGCOMM conference on Internet measurement*, pp. 267–280, ACM, 2010.

# Vita

- **Education**

- B.Sc., King Saud University, 2003
- M.Sc., King Saud University, 2006
- Ph.D., University of Kentucky, 2018

- **Publications**

- F. Alharbi, and Z. Fei, “Improving the Quality of Service for Critical Flows In Smart Grid Using Software-Defined Networking”, *IEEE International Conference on Smart Grid Communications (SmartGridComm)*, 2016.
- F. Alharbi, and Z. Fei, “An SDN Architecture for Improving Throughput of Large Flows Using Multipath TCP”, *The 5th IEEE International Conference on Cyber Security and Cloud Computing (IEEE CSCloud)*, 2018.